



Mineral Products Association

Guide to Avoiding Contact with Moving Machinery and Isolation

The narrative and practical examples used in this document have been taken from the significant amount of materials that were received from MPA members after a request for sharing best practice. Thank you to all those that contributed with the singular uncompromising objective to reduce the risk of Contact with Moving Machinery.

Background

In 2017 the Mineral Products industry saw an unprecedented number of incidents that resulted in fatal consequences across the mineral product sector. In response, and at the request of MPA Council and Board, the MPA Health and Safety Committee looked back at the fatal incidents over the last decade, identifying 6 high consequence hazards, 'The Fatal 6', that have been the main cause of fatalities over that period. The identified 'The Fatal 6' high consequence hazards are: **Contact with moving machinery and isolation (including stored energy), Workplace transport and pedestrian interface, Work at height, Workplace respirable crystalline silica, Struck by moving or falling object, Road traffic accidents.** A working group involving MPA members has been established for each topic to develop useful guidance and resources, helping to make a difference by reducing the risk of these high consequence hazards occurring across the industry.

Adopting a systematic and holistic approach to managing risk and inculcating a safety culture will protect employees and all those affected by workplace activities.

The factors that give rise to risk are interdependent and cannot be examined in isolation, it is vital therefore when managing risk to be aware of this interdependency. There are numerous factors that influence good risk management, the most successful capture the requirements of both legal compliance and influencing safe behaviors, but never considered as one being more important than the other.

The simple risk management diagram gives a holistic overview of what you might consider and how they interact.



Introduction

Contact with moving machinery and isolation

In this industry, 22% of fatalities are as a result of contact with moving machinery, which is often associated with reactive maintenance and a failure to correctly isolate all sources of energy.

Fatalities or serious injuries are mainly due to a failure to isolate machinery, poor guarding, inadequate exclusion areas, poor procedures or a failure to follow them. These tragic incidents often involve horrific injuries associated with entrapment, crushing, amputations, pinching, lacerations or burns.

In many cases these incidents were foreseeable and avoidable. Reducing them will be achieved by the implementation of the following:

- Better designed plant and processes
- Better designed guarding
- More effective supervision
- Better risk assessments
- Additional training
- Following LOTOTO isolation procedures
- Use of appropriate exclusion zones
- Updated safe systems of work (SSoFW)
- Ensuring continued monitoring of SSoFW and condition of safety equipment
- Other related measures.

This Guide has been designed to assist supervisors and managers and complement other industry technical guidance.



This Guide is laid out in order of the '4Ps' of Safety Management to support supervisors and managers on site:

People Plant Process Performance

People - Starting with leadership, this section covers all elements of the individuals who work within the safety management system. People is the first area of focus within this document.

Plant - Good safety management systems demand plant is vigorously designed, constructed and commissioned. These robust standards then need to be maintained throughout the plant's life-cycle.

Process - Good safety management supports strong operational and emergency responses with a structured process, appropriate to each level.

Performance - In line with the concept of continuous improvement, performance looks to consistently measure the success of a safety management system.

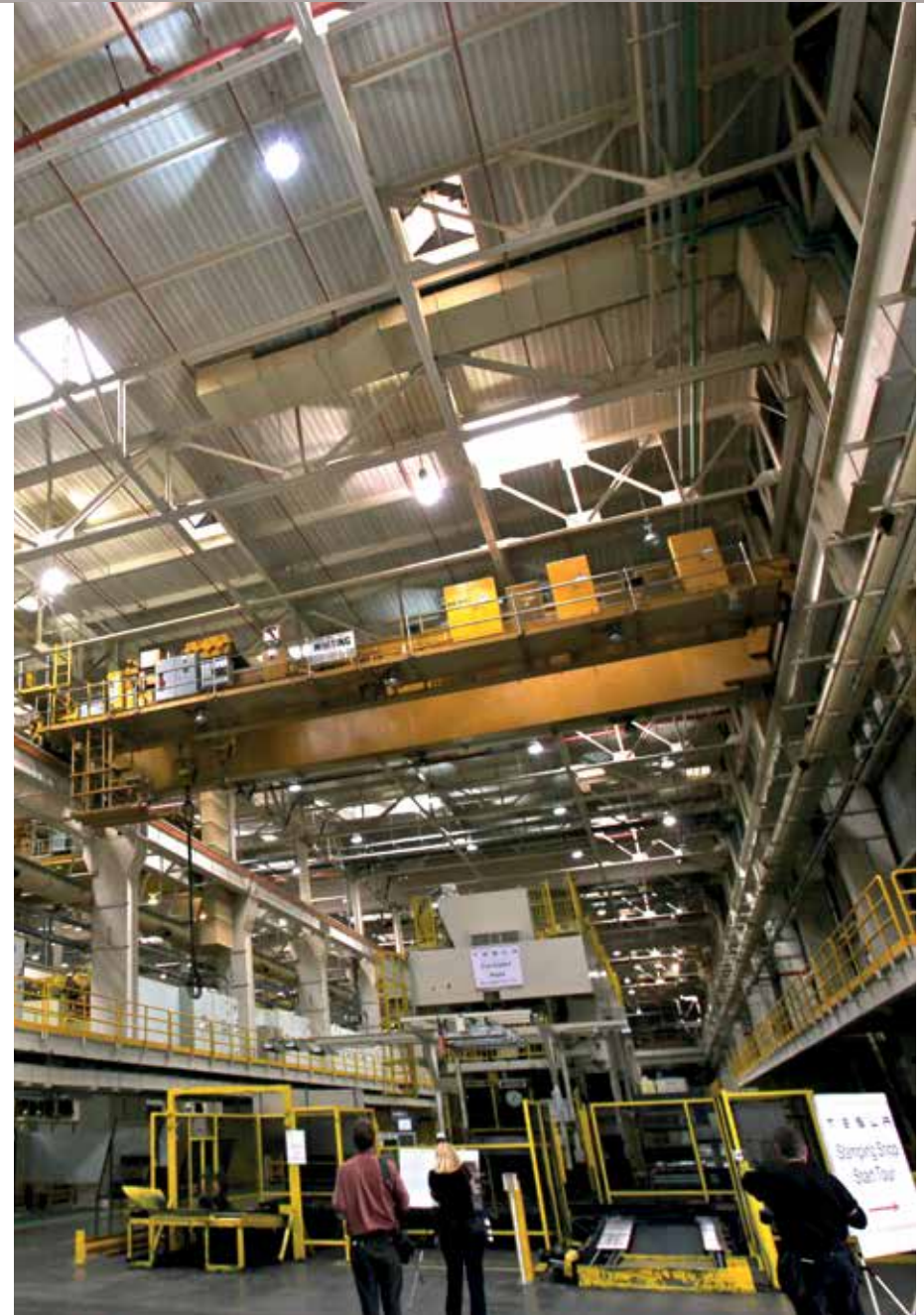

Key Definitions

Responsible Person – This is an authorised person who has completed the Risk Assessment for the EQUIPMENT that requires Isolation. This person may also be the Isolation Controller.

Any reference to an ‘Employee’ as a responsible person will include all persons involved in the task, including subcontractors, unless otherwise specified.

HIRA – Hazard Identification and Risk Assessment

Equipment – This is any Machinery, Plant, Equipment or Process that could potentially be a source of Hazardous Energy, which would require that Hazardous energy being isolated or removed prior to any work being undertaken.

Associated Equipment – Any equipment that may be part of the process that could be a source of Hazardous Energy affecting the EQUIPMENT being worked on and could cause harm to persons carrying out the Task. Examples of this could be Hoppers, Chutes or Conveyors feeding onto or from the EQUIPMENT being worked on. Pneumatic air supplies, fuel lines, or any other form of Hazardous Energy which could cause harm to persons carrying out the Task.

LOTOTO - Lock-Out, Tag-Out, Try-Out

Lock-Out: The placement of a personal lock on an isolating device in such a position that prevents the operation (i.e. movement) of the isolation device and energisation of EQUIPMENT until removal of the lock in accordance with established procedures.

Tag-Out: Placing a tag on a lock or point of isolation to identify who placed the lock and when it was placed.

Try-Out: The attempt to energize or start-up EQUIPMENT that has been fully isolated to verify that it is completely de-energized and inoperable

Isolation Certificate - This forms part of the HIRA process and is a written procedure that identifies the task being undertaken, the sources of Hazardous Energy requiring isolation and where these Energy sources are to be isolated, the names of all persons applying a personal lock and the lock identification, a method of transferring the control of the isolation to another person, and a section to sign off the Equipment as safe to operate once the task has been completed.

Isolation Lock - A padlock with a single key. No other key used on site shall be able to open the isolation lock, and no other lock used for isolation shall be able to be opened by the key to this lock. Isolation locks bought from specialist suppliers can be obtained that include references to the fact the padlock is being used for isolation and may include the owner’s name or a reference number marked on the lock. Where any padlocks are supplied with duplicate keys the duplicate key **MUST BE DESTROYED**.

Tag - A durable label applied at the isolation point designed to inform other people that the EQUIPMENT has been isolated for the safety of people at work. Tags on isolation locks are used to identify the user of a specific lock (particularly useful where a bank of isolation locks are used ‘on demand’ in preference to individually issued named locks).

Multi-hasp - A device used when locking the isolation device which permits several isolation locks to be attached to a single isolation point. Several multi-hasps can be connected together where required to permit sufficient isolation locks to be attached. It must not be possible to remove a multi-hasp device whilst it is secured with an isolation lock.

Lock Box - A physical box designed to hold isolation lock keys, which provides a single point for workers to apply their personal isolation locks.

Residual / Stored Energy - Remains in machinery or equipment after it is shut down.

Energy Isolating Device - Physically prevents transmission or release of hazardous energy.

De-Isolation - Removal of isolation devices in order to re-energize the system.

Hazardous Energy - Any source of electrical, mechanical, hydraulic (liquid pressure), pneumatic (air), chemical, thermal, radioactive, gravitational, stored, residual, potential or any other energy that, if not controlled, could cause injury to personnel or damage to property.

Contents

- 2 Introduction
- 6 Key Definitions
- 10 The PDCA cycle
- 17 People - Safer by Competence**
- 18 What Role does Leadership Play when Considering Contact with Moving Machinery and Isolation?
- 24 Good Safety Conversation
- 25 How to Conduct a Quality Safety Conversation
- 28 Example of Good Safety Conversation
- 30 Best Practice Action Plan
- 32 Actions Agreed
- 34 Understanding Competence
- 35 Training
- 36 Training Records
- 40 Responsible Person
- 43 Responsible Person Example
- 49 Plant - Safer by Design**
- 50 Principles
- 56 Complete your PUWER Inspections
- 59 Best Practice Principles
- 60 Purchasing
- 64 Common Guarding Standards
- 68 Best Practice Safer by Design
- 70 Plant and Equipment
- 72 Plant and Equipment - Head Drum Guarding
- 73 Tail Drum Guards
- 74 Skirting Guards and Batch Feeder Belts
- 75 Return Rollers
- 76 Belt Tension Points and Gravity Take-Up Unit (GTU)
- 77 Snub Drum Conveyors

Contents

- 78 Screw Conveyors and Dewaterers
- 80 Concrete/Readymix Plant
- 82 Guarding Motors
- 83 Feed Hoppers
- 84 Skips
- 86 Primary Crusher Guards
- 88 Screens, Vibrators and Fly Wheels
- 90 Asphalt Plants
- 92 Robot Guarding
- 94 Energy Stored in Plant
- 99 Best Practice Mobile Plant
- 100 Labelling/Identification ISO7010
- 104 Isolation Equipment
- 108 Best Practice Isolation Equipment
- 109 Process Safer by Sharing**
- 112 Identifying Sources of Energy
- 114 Best Practice Identifying Sources of Energy
- 116 Simple and Complex
- 118 Written Isolation Procedures
- 124 Recording LOTOTO Events
- 126 Test Run
- 128 Shift Handover
- 134 LOTOTO
- 136 Best Practice LOTOTO
- 137 LOTOTO 9 Steps
- 143 Performance Safer by Association**
- 146 Audit
- 150 Reporting of Incidents/Near Miss/Investigations
- 156 Leading/Lagging Indicators
- 160 Reference
- 161 Website Links
- 162 Appendix



The PDCA cycle

This guide follows the **Plan, Do, Check, Act (PDCA)** approach to explore a variety of factors aimed at reducing incidents involving contact with moving machinery and isolation. This guide will look at all energy sources beyond just electrical energy, and applying the PDCA approach ensures that this can be done thoroughly and appropriately to meet the individual needs of the business. The PDCA framework is a practical way for businesses to make positive changes above the minimum standards

The PDCA approach achieves a balance between the systems and behavioural aspects of management. It also treats health and safety management as an integral part of good management generally, rather than as a stand-alone system.

PDCA can be applied to contact with moving machinery and isolation management in exactly the same way as it can in other parts of the H&S Strategy for a company.

Firstly, using using risk assessment principles we need to establish where these risks are apparent using data and incident analysis tools, and ensure that we have the required knowledge on how these risks are controlled, benchmark against industry best practice, and evaluate our existing procedures to see if they are fit for purpose.

We need to look for easy, simple and effective contact with moving machinery and isolation plans and procedures, in order to give our managers the tools to “self assess” their operations and understand how each one of the risks can be controlled

and mitigated.

However it is not just physical equipment we need to control; we also have to understand the implications of employee and contractor behaviour as we look to enhance the control measures either in place or the ones we intend to add.

Why and how these control measures work, why they are required, appropriate checks of applicability and feedback mechanisms need to be communicated effectively to everyone.





The PLAN stage establishes where a business is starting from and where it intends to get to:

- Say what a business wants to achieve, who will be responsible for what, how these aims will be achieved, and how success will be measured. It is recommended to write down this policy in order to effectively deliver it.
- Decide how the business will measure performance. Think about ways to do this that go beyond looking at accident figures; look for leading as well as lagging indicators.
- Remember to plan for changes and identify any specific legal requirements that apply to the business.



Do – Identify the business risk profile

- Assess the risks, identify what could cause harm in the workplace, who it could harm and how, and what can be done to manage the risk
- Decide what the priorities are and identify the significant risks

Do – Organise any activities to deliver the PLAN with the aim to:

- Involve workers and communicate, so that everyone is clear on what is needed and can discuss issues
- Develop positive attitudes and behaviours
- Provide adequate resources, including competent advice where needed

Do - Implement the PLAN

- Decide on the preventive and protective measures needed and put them in place
- Provide the right tools and equipment to do the job and keep them maintained
- Train and instruct, to ensure everyone is competent to carry out their work
- Supervise to make sure that arrangements are followed





Check - Measure the performance

- Make sure that the PLANs have been implemented; 'paperwork on its own is not a good performance measure
- Assess how well the risks are being controlled and if the business is achieving its aims; in some circumstances formal audits may be useful
- Investigate the root causes of accidents, incidents or near misses/hits

PDCA cycle - understanding your risk profile

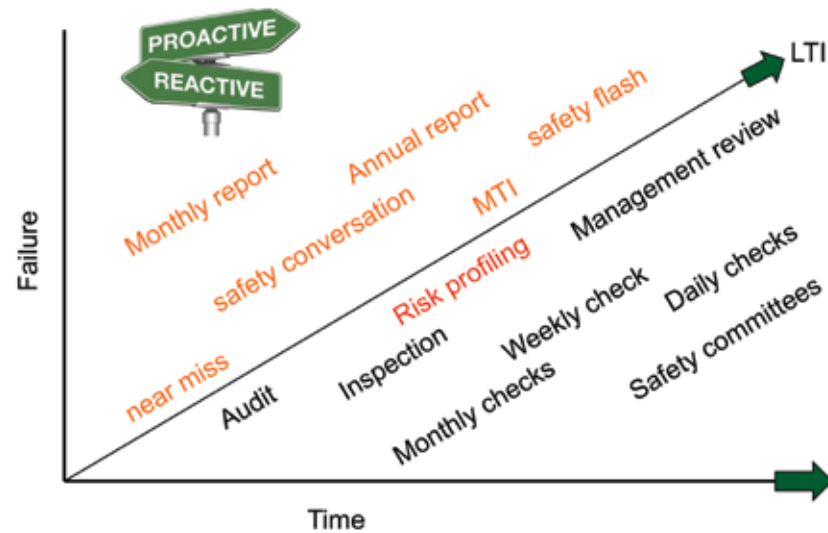

Check - Review the performance

- Learn from accidents and incidents, ill-health data, errors and relevant experience, including from other organisations
- Revisit plans, policy documents and risk assessments to see if they need updating
- Take action on lessons learned, including from audit, inspection reports, reviews, safety conversations, misses/hits, etc.

PDCA cycle - preventing reoccurrence

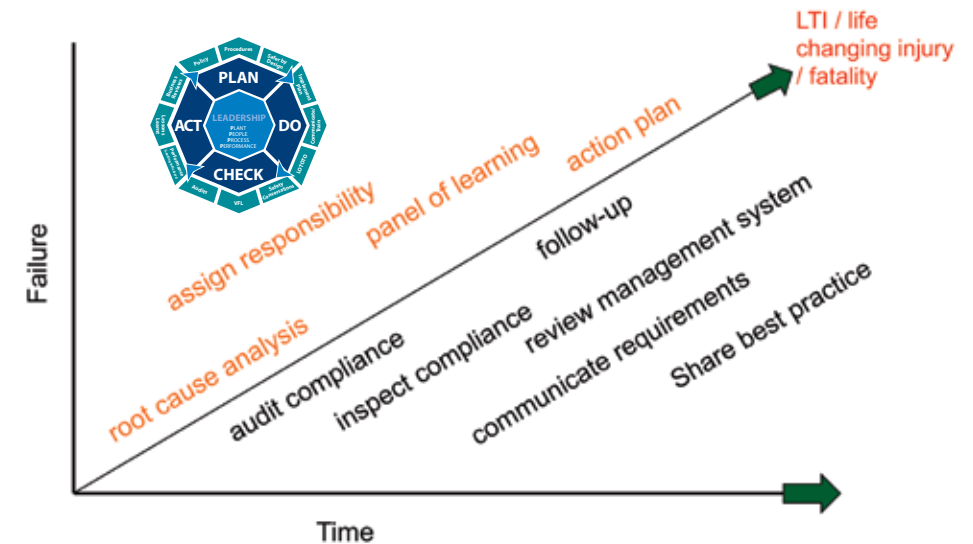



People: Safer by Competence

What Role does Leadership Play when Considering Contact with Moving Machinery and Isolation?

Organisations, and the directors and managers that run them, have to understand firstly what health and safety (H&S) leadership is, and why it is so important. They need to understand their legal responsibilities for the positions they hold, but it is the H&S leadership in their organisation that will be the determining factor in progressing to creating a strong H&S culture and making a change to a safer and healthier workforce.

Managers have to understand that H&S is a business process in the same way that finance, HR, purchasing, sales etc are. And whilst warm words such as “we take H&S seriously” or “it is our number one priority” are important it is the understanding that the H&S process requires dedicated management time and resources, and this is not found to be the case in practice when examined in detail.

So all this requires planning and resources, but the senior leadership has to take full responsibility for H&S culture and processes in the business. It is the leadership’s visible commitment to H&S that is the key to holding the segments of the H&S system together and creating a sustainable long-term safety culture improvement. Safety is a “line management” responsibility, which is why so many H&S professionals prefer the title H&S Advisor or Business Partner as opposed to H&S Manager or Director.

Senior Leaders also have to understand that it’s not just about incidents, it’s about ZERO HARM as a strategic vision; we have to look at incidents, health and sickness in the workplace as a whole. They also have to believe it is possible; and it is!

“Operational excellence goes hand in hand with safety excellence”



When considering contact with moving machinery and isolation, VFL would facilitate:

- Everyone on-site to look out for one another, rather than an ‘us vs them’ mentality or ‘blame culture’
- Site Manager and Supervisors to take proactive measures to improving isolation processes, equipment, guards and overall site safety.
- Operatives to speak up or suggest changes where improvements could be made
- Safety to become everyone’s responsibility as the business moves towards an interdependent culture.

Sustainable H&S performance

When considering the business approach to contact with moving machinery and isolation, the strategic approach - as outlined in this guide - goes above and beyond incidents, instead taking a holistic approach.

A way of introducing senior executives to the concepts of Safety Leadership is through engaging with course materials such as IOSH Leading Safety in conjunction with the MPA or H&S for Directors courses. The training of all senior leaders on VFL is critical.

The first challenge for leaders is to understand ALL incidents are avoidable. Lock-Out, Tag-Out, Try-Out can be implemented, and operatives can always be isolated from energy sources. This first step is difficult for some business leaders to accept. Commonly the reaction of leaders to an incident, for instance a worker being electrocuted, is to put in place better procedures and physical guarding, but commonly the behaviour aspect of “why was the energy not isolated” is not fully appreciated. It is this aspect that managers sometimes miss.

Investigations in large organisations indicate the root cause of up to 96% of all incidents can be linked back to human behaviour (the remaining being “acts of god” or equipment failure).

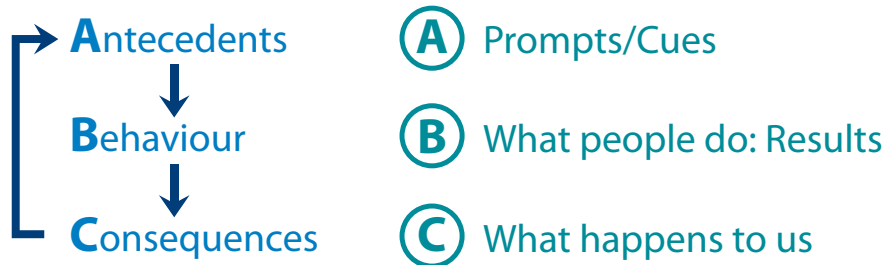

To understand this fully, managers must recognise that, for instance, if an energy panel overloads, it is not necessarily equipment failure. It could be either the designer made a mistake, the manufacturer put it together wrong, the operative noticed a problem and didn't report it, or a manager got a defect sheet and didn't act. It is not necessarily a “violation” but it could be a mistake, error, misjudgement or lapse of concentration. Either way, it all relates to people working in cultures that excuse their behaviour.

VFL training includes the theory around why people do things, as human behaviour is generally predictable. Furthermore, people respond to leadership messages. If the leadership culture pushes for production, this will always be prioritised over safety, whereas when health and safety is the focus, the workforce will follow suit. One useful view of assessing the business H&S maturity is analysing the business' current culture against the Bradley Curve. The DuPont Bradley Curve identifies four stages of safety culture maturity: Reactive, Dependent, Independent and Interdependent.

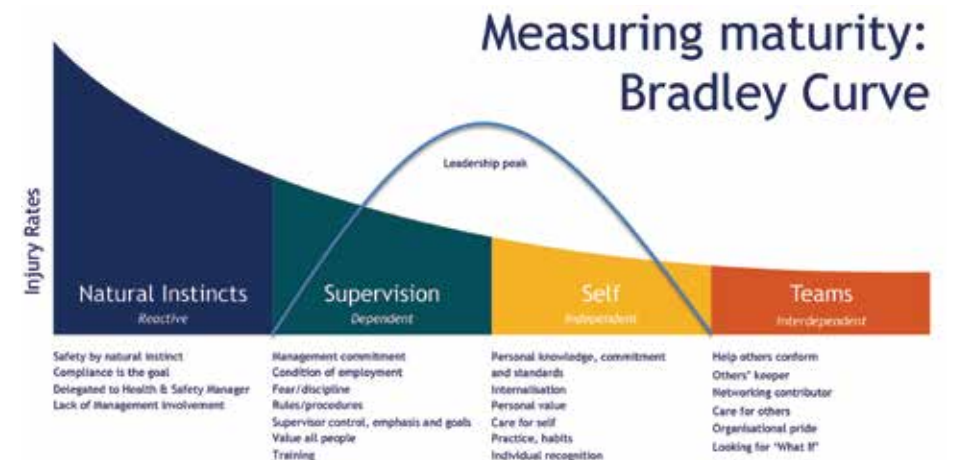

Reactive Stage - People don't take responsibility and believe accidents will happen.

E.g. on a site with no isolation plan in place, following an incident where an individual is dragged into a conveyor, the business responds by terminating the employment of the injured person.

Dependent Stage - People view safety as following rules. Accident rates decrease.

E.g. on a site with no isolation, following an incident where an individual is cleaning a conveyor when it is unexpectedly turned on by a colleague, the business responds by issuing a new rule that all cleaning must take place outside of production hours, and reprimands are distributed when these rules are broken.

Independent Stage - People take responsibility and believe they can make a difference with actions. Accidents reduce further.

E.g. Following an incident where a machine is switched on with the guarding removed, the business responds by issuing a safety alert including details of the injuries incurred, reminding everyone to follow the isolation plan in order that they can go home safely. Everyone's personal padlocks are checked, and Supervisors are asked to run a Toolbox talk on isolation safety asking the question: "How would your life be affected if you were electrocuted?"

Interdependent Stage - Teams feel ownership and responsibility for safety culture. They believe zero injuries is an attainable goal.

e.g. Following a near miss where a machine is switched on with the guarding removed, the workforce came together in a working group to develop technological solutions in the form of safety light grids to prevent a future incident. These were budgeted, trialled and rolled out across the wider business.

VFL must be VISIBLE in the workplace. When applied to isolation this means managers need to be on site speaking with everyone who comes into contact with isolated machinery or who isolates machinery themselves. By doing this, the workforce will FEEL the importance of safety coming directly from the LEADERS of the business.

MPA Member - Their Journey

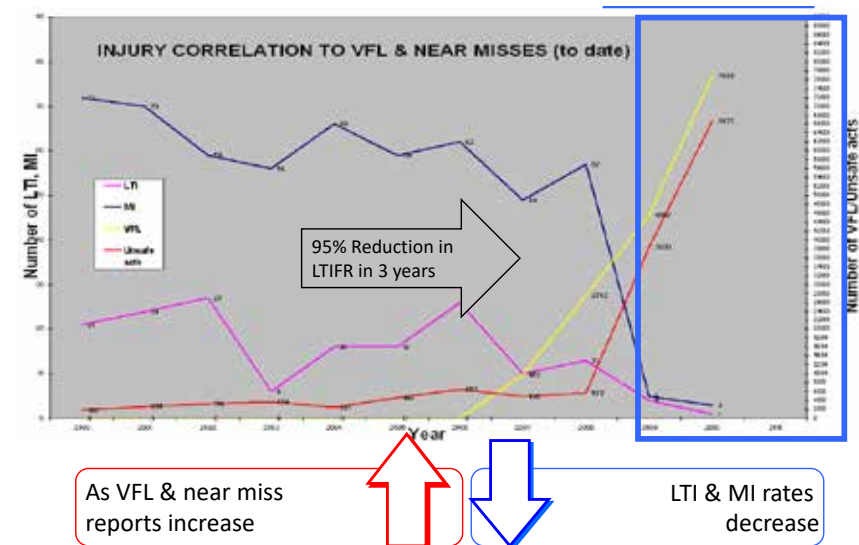

Once in place it must be in management's annual appraisals and bonus schemes to operate effectively and be actively managed. An effective VFL approach will see:

- Incident numbers fall
- Near Miss/Hit numbers rise

The outcome of a successfully engaged management team relies on an understanding that everyone has responsibility for health and safety, and that includes other board members of other functions. These roles do not always see safety as part of their responsibilities. Wise organisations ensure that each board member is allocated some part of the H&S system to manage with safety support.

Good Safety Conversation

Safety Conversations are practical tools utilised by Management, regardless of their function, to practise Visible Felt Leadership (VFL), in order to promote wider change within a business' organisational culture.

Questions every site should ask:

- Where is the business currently placed on the Bradley Curve?
- What areas should be targeted initially to have the greatest impact on improving safety culture?
- What training do managers need in order to hold an effective Safety Conversation?
- Do managers need any additional resources in order to facilitate a Health and Safety Conversation approach?
- What needs to be communicated to the wider workforce in order to prepare them for what to expect?
- What other tools can be used in combination with Health and Safety Conversations in order to empower the wider workforce to act upon their commitments during these conversations e.g. Near miss/hit reporting tools.
- How will Safety Conversations be recorded?
- Who will review Safety Conversations and identify trends to send out to those trained?
- How will the results be communicated back to the Management Team as well as the wider workforce?

How to Conduct a Quality Safety Conversation

Step 1: Stop and observe.

Observations give a manager an opportunity to understand the environment that people are working in as well as the attitude of those people working. Observations should include not only areas for improvement, but opportunities to praise.

Step 2: Introductions (unless a manager is already known by the person).

A safety conversation should begin by the manager offering their name and perhaps some background as to where they are from and what they do. The manager should then always invite the same in return.

Step 3: Tell them what you're doing.

For some people, a manager discussing health and safety can be nerve-wracking (particularly in reactive or dependent cultures) so an introduction of safety conversations can be reassuring. This should be short and to the point. For example: "I'm out on site talking with people about their jobs, to discuss any risks and what we can do to overcome them. Do you have a few minutes to talk?"

Step 4: The task and its stages.

Discuss the task being carried out by asking open questions. A manager should never make assumptions about the task, but should work towards having a full understanding of all the stages the task entails. This stage is important: it gives the person the opportunity to get involved in the discussion, and the more they do, the more buy-in they will have to changing their own behaviour.

Step 5: Give praise for safe behaviour. This re-enforces good habits.

Step 6: Ask about the worst thing that could happen.

A good approach at this stage would be to ask these 3 questions in quick succession:

“What’s the worst incident that could happen doing this job?”

“What could be the consequences of that happening?”

“How could that happen?”

Some tasks or environments may not have obvious hazards so a manager should learn to probe to ensure that an individual is really doing everything necessary to prevent an accident, not only to themselves, but to others around them. If during the observation stage, a manager sees something that gives them cause for concern, this is a good point at which to ask about it.

Listening skills are key and should be practised by managers before engaging in safety conversations if possible.

VFL is all about listening, how do we show it?

- Non-verbal response (e.g. nodding)
- Verbal response
- Not showing impatience to speak
- Playback - summarising what the person has said as you go along
- Finally, summarise

Step 7: Find the root cause of any unsafe behaviour or condition.

If unsafe behaviour has been identified in step 6, consider the question “Why do you take the risk?” in order to establish root cause.

Step 8: Get solutions to the unsafe behaviour or condition.

The aim of any safety conversation is to encourage the workforce to act safely without management supervision. Open questions such as “what can you do?” and “how could you do that?” encourage an individual to generate their own solutions.

Step 9: Get commitment to act.

The key question here is. “When can you do that?” every accident investigation reveals a plethora of simple solutions AFTER the event, so management should be aiming to use safety conversations to fish out those solutions before the accident even occurs. If several solutions drop out of the discussion, it’s useful to summarise them. Managers should always remember to give praise for the solutions and commitment.



PLAN	DO	CHECK	ACT
Establish where on the Bradley Curve the business currently sits and commit to change starting from the top of the hierarchy and working down	Train management across all functions on how to conduct a quality safety conversation. Need to put in place recording databases and analysis tools in order to evaluate high-risk areas	Record in a simple manner safety conversations that have been conducted in a central location and consider time frames to review	A Safety Conversation approach can take up to three years to become embedded within a culture, so the next PLAN needs to focus on initial success stories within the business to keep the conversations positive

Example of Good Safety Conversation

MANAGER: Good Morning, my name is Sam, I'm a visiting Manager for this site. Can I ask what your name is?

OPERATIVE: Yeah, Billie.

Sam: Thanks Billie, I am looking to conduct a safety conversation, do you have a quick ten minutes to discuss what you're doing here?

Billie: Yeah, that's no problem.

Sam: I can see that you've removed the guard.

Billie: Yes, do you see that tag hanging from that handle over there?

Sam: Yes.

Billie: That's my lock-out tag. I have locked out with my padlock, which I carry as a part of my maintenance kit, and attached the tag so anyone that turns the machine on will know I am working on it.

Sam: That's safe and efficient of you Billie. It means a lot to me and this business to see such measures being taken.

Billie: Thanks.

Sam: Well as you've been servicing this machine, are there any other safety concerns you have that you would like to discuss?

Billie: Well, thinking about LOTOTO, I had a friend who had a lock that any key seemed to work with. The business reckons they are paying for a 40,000-to-1 guarantee on their padlocks, but this lock seemed to accept any old key. I wouldn't want to get a lock like that.

Sam: Yes that is concerning, did you report it?

Billie: Well, no. I can complete a near-miss form, but it wasn't a near miss as nothing has happened yet, and it's not even my lock.

Sam: I understand Billie, but you can use your near-miss reporting tool even for unsafe conditions such as that padlock. It might be that there are lots of padlocks like that, but until the company is told it won't be aware that maybe there is a problem with its supplier.

Billie: Yeah, that makes sense. I have a brother who works for a different company, and he says they use personalized padlocks with their names stamped directly on them.

Sam: That sounds like an excellent idea. Why don't you submit a near-miss report on the first padlock and include the suggestion of personalized padlocks? I can push it through if you don't hear back.

Billie: Oh, I didn't know you could do that. Yeah I will.

Sam: Thanks for your time today Billie. I'll keep an eye out for your near-hit report.

Billie: Thank you.



Best Practice Action Plan

A critical part of the PDCA cycle discussed in the earlier pages is to formalise the whole process into an action plan. This plan should be the co-ordinating document pulling together all the initiatives that emerge from the detailed risk profiling of the business and include the actions identified as part of the analysis of both “reactive” and “proactive” information being recorded in the business.

An example of a document is shown overleaf. All businesses with good H&S performance ensure effective management of all processes in the business. It is not about procedures, though they are part of the processes, it is about managing risk, demonstrating leadership and engaging staff.

Therefore a strategy-focused PDCA plan should contain items from the company vision and new procedures coming through, as well as links to other functions such as communications, HR and finance.

There are several inputs, some of which are listed below:

1. Company Vision & Policy
2. H&S Plan
3. Management Review
4. Targets & Goals for the Business
5. Management H&S Objectives
6. Employee Engagement & Incentives Processes
7. Risk Profiling Process & Actions
8. Safety Committee Feedback
9. Budget & Resource requirements
10. Gap Analysis against Legal & Recognised Good Practice
11. Reporting & Sharing Good Practice Processes
12. H&S Procedural Processes
13. Health & Sickness & Wellbeing Processes
14. Auditing & Monitoring Processes
15. Communications
16. Training & Competence

Actions agreed

Action	Business Solution
Complete PUWER Assessment ensuring all equipment used in the workplace has either been constructed or adapted so that, in the conditions in which it is to be used, it doesn't pose an unacceptable risk to people's health and safety	10. Gap Analysis against Legal & Recognised Good Practice
"Person in Charge" process to be rolled out in regards to training, documentation and implementation throughout the business working directly with moving machinery and isolation	12. H&S Procedural Processes
All Managers to engage in three "Safety Conversations" regarding conveyors, moving machinery or isolation	5. Management H&S Objectives
Nominate an "Isolation Champion" within each site to maintain the Isolation Stations. Prize awarded for most pro-active champion across the business	6. Employee Engagement & Incentives Processes
Audit the labelling and identification of pipework in line with BS1710 ensuring that all equipment meets standards	14. Auditing & Monitoring Processes

Responsible Person/Persons	Date of Completion
Health and Safety in line with Site Managers	April 20##
Line Managers and Supervisors within Operations	August 20##
Senior Management	November 20##
Site Management/Isolation Champions	July 20## - Awards December 20##
Operatives	June 20##

This is an example of one MPA Members approach to an action plan

Understanding Competence

People carrying out Isolations need to be competent and given written authorisation.

Competence can be described as the combination of training, skills, experience and knowledge that a person has and their ability to apply them to perform a task safely. Other factors, such as attitude and physical ability, can also affect someone's competence.



Training

Training is an asset to a business as well as to an individual. By ensuring that a workforce is 'competent' a business can take advantage of those individuals who already possess several skills and enable those who don't to acquire them as a part of their personal development. Effective training will improve not only the safety, but also the quality and efficiency of any work done whilst reassuring workers that they are valued by the company, leading to raising staff retention rates.

Identify the required competencies for the plant you are running on your site. These can be in the format taken from operational handbooks. These competencies should develop a framework with the view to achieving the following results:

- A reduction in incidents and near misses through poor competence
- An increase in production
- An increase in management trust
- A reliance on the framework to underpin employee reviews/appraisal
- Provide better analysis of training needs
- Show enhanced career management

Competency Matrix			Required Completion Date	Year 1													
Role:	Operator	Completion Date															
Employment Start Date:	Feb 20##																
Qualification	Required Completion Date	Signed off by	Date														
Base Competency																	
Risk Assessment Understanding and Completion	Within 6 months Employment	J.Bloggs	July 20##														
Machinery Hazard Awareness	Within 6 months Employment	J.Bloggs	July 20##														
Familiarisation of Site	Within 6 months Employment	J.Bloggs	July 20##														
Business Induction	Within 3 months Employment	J.Bloggs	April 20##														
Business Trained	Within 3 months Employment	J.Bloggs	March 20##														
Practical test of Physical Isolation Process	Within 6 months Employment	J.Bloggs															
Premium Competency schedule																	
Industry Skills	Within 9 months Employment																
Legal LOTOTO Regulations	Within 9 months Employment																
Safety Procedures for Confined Spaces	Within 9 months Employment																

Training Records

Once training has been delivered to the relevant individuals, records need to be kept in a place that can be accessed by anyone who may need to refer back to them.

The records must contain:

- The level of training provided and what that training enables the individual to do
- A confirmation of the way levels of understanding have been assessed
- The specific job role of the person trained. A change of roles or responsibilities may require additional training
- The date of the training to help identify when refresher training will need carrying out
- Who delivered the training, whether it was in-house or an external organisation.

Contractors or those who aren't directly employed may keep a copy of the training records for their own files, but it is imperative that the original training records stay within the business. All training records need to be stored in conjunction with current GDPR legislation.

For larger organisations with several sites, a training record of authorisation system might be the best solution to recording an individuals training records.

A record of authorisation is used in addition to a core training log. Rather than being kept by HR or Personnel, the record of authorisation should be made available as and when it is required at site level. Every time additional training is carried out, e.g. site-specific training, it is logged in the record of authorisation as proof of overall competence.

Questions every site should ask:

- What format are your training records in?
- Where are training records kept?
- Are contractors provided with copies of their training records so the original can stay with the business?
- How is refresher training prompted and managed?
- How is relevant training managed when an individual changes job roles or responsibilities?
- Does the business have more than one record kept on site?
- Would a training record of authorisation help to show competence across various sites?
- Would a digital record system reduce administration of training records whilst still remaining useful to the trainers and trainees?

Guide to Energy Isolation and LOTOTO

Personal Details

Employee	Contractor	Visitor	Driver

Name:

Job Title:

Tel: Mobile:

Company Name:

Tel: Mobile:

Manager Name: Mobile:

Address:

Training Record
 The above employee / contractor has successfully completed the Hanson Isolation and Lockout Training. They can be authorised by the site manager within this booklet and on UKSP008.F7 for Simple and / or Complex isolation events as deemed appropriate by the site Manager (dependant on their site skills, knowledge and experience).

Trainer Printed Name:

Trainer Signature:

Date:

Hanson UK Guide to Energy Isolation & LOTOTO | 35

Example of site document to log training



PLAN

Decide upon a system of retaining training records that is relevant, accessible and useful to individuals being trained as well as the business

DO

Bring the training records in line with the approach decided upon in the PLAN

CHECK

Monitor the training records with specific focus upon the refresher training dates to CHECK that the system can be relied upon

ACT

Consider whether the training records can be converted into a record of authorisation or digital format for future PLANS

Responsible Person

Many different titles are used across the industry to describe people who are permitted to complete isolations. To see a full list of these titles used consistently throughout this document, there is a 'Definitions' page within the 'Process' section of this guide. For the purpose of this document we will be referring to all of these individuals as 'Responsible Persons'.

A Responsible Person is anyone who is competent and given written authorisation.

Based on the complexity of the task, which will be determined by the risk assessment, a business may need to authorise an individual with a higher level of competency as the Responsible Person.

A Responsible Person is someone who has been authorised in writing, following confirmation they have the suitable skills, knowledge and experience to complete equipment isolations safely.

All authorisations need to be documented and copies kept with both the individual and the business.

If the correct training has been completed and signed off, a competent person would then be considered, authorised to conduct isolations of every variation. However, it is down to the discretion of each site to determine if an individual is competent enough to work on their site without supervision.

Either way, only those who have been authorised in writing can carry out equipment isolation activities.

Anyone authorising a person to complete an isolation need to consider the following. The individual should:

- have received a suitable induction to the business and site
- have knowledge relevant to the specific equipment and isolation methods
- have attended training covering methods of isolation of all forms of energy
- have completed an assessment to confirm understanding
- have been assessed completing a practical demonstration of equipment isolation
- be aware of their limits of knowledge and understanding

The image shows two overlapping forms from the Hanson UK Guide to Energy Isolation and LOTOTO. The top form is a 'SITE AUTHORIZATION' card. It has a header 'Guide to Energy Isolation and LOTOTO' and a title 'SITE AUTHORIZATION'. It contains fields for 'Site Name', 'Manager Name', and 'Manager Sig'. There are two checkboxes: 'Level 1 - Simple Isolation' and 'Level 2 - Isolation Controller', each with a 'Date' field. Below these are 'Restrictions' fields. The bottom form is an 'Employees Task Authorisations' sheet. It has a header 'Hanson UK System Procedure' and 'Employees Task Authorisations'. It contains a table with columns: 'Plant Item', 'Date of authorisation', 'Signature of Responsible Manager', 'Signature of Authorised Employee', and 'Epic assessment'. There are also fields for 'Employee Authorised: ... (EMPLOYEE NAME)', 'Signature of employee confirms acknowledgement of authorisation, duties & responsibilities are fully understood', and 'You are hereby authorised as trained & competent to operate the following equipment / undertake the following tasks at: ... (SITE NAME)'. The bottom of the form has a footer 'Document Number UKSP008.F7 Version 1 Page 1 of 2'.

Example of Site document to log training

Responsible Person Example

Contractors often fall under one of two categories:

- Contractors coming onto site for maintenance for site based operations.
- Contractors commissioned to run the site as employees

Regardless as to their function, they must go through the same procedures to be considered Responsible Persons.

If a contractor is competent externally, but does not go through the in-house training, they would not be considered a Responsible Person and therefore would need to be supervised by a Responsible Person from the business.

If contractors provide their own personal padlocks, they must be in line with the isolation equipment requirements identified in this document.



CRH Tarmac Cement and Lime
Safety Procedure



3: Energy Isolation

Energy Isolation Authorisation Form:

Tarmac Cement and Lime Employees Authorised Individual/Responsible Person

Section 1: Definition of Responsibilities and Training level required:

1. **Authorised Individual (AI):** An individual with the required skills, experience and knowledge with regard to the Tarmac Cement and Lime Energy isolation procedure and the equipment to carry out simple isolations and lock off safely using appropriate devices such as isolators, dampers and valves.
Only individuals that have completed their induction period, their role competences and undertaken the site specific isolation authorised persons training can be classed as AI's. AI's are permitted to perform Simple Isolations and work under a Complex Isolation under the control of the Responsible Person (RP).

There are four distinct Authorised Individuals (AI's):

1. **Authorised Electrical Individual:** May be permitted to operate High Voltage Local Isolators up to 3.3KV, provided appropriate training has been given. The Head of the Electrical Department shall confirm where this situation is applicable.
2. **Electrical:** Appointed in writing by the Head Electrical, who shall specify the type of equipment for which this individual is classed as competent and confirm that appropriate training has taken place. Electrical competent individuals are permitted to perform electrical isolations when they have completed the appropriate electrical isolation training.
3. **Mechanical:** Appointed in writing by the Maintenance Manager who will specify the area and the type of equipment for which this individual is classed as competent and confirm that appropriate training has taken place.
4. **Process:** Appointed in writing by the Production Manager who shall specify the type of equipment for which this individual is classed as competent and confirm that appropriate training has taken place.

2. **Authorised Contractor:** It is a sub-contractor who has been suitably trained and has the required experience to perform isolations of the process plant and equipment using isolators, dampers, valves, barriers, etc. Authorised Contractor(s) will be approved by the Head of Department employing that Contractor.
3. **Responsible Person (RP):** An appropriately trained person who is responsible for any group/complex isolation, and for the completion of the Energy Isolation Procedure. This individual must ensure all affected AI's are fully aware of the hazards involved and in compliance with the hazardous energy control procedures.

The RP is the first person to LOTOTO and the last person to remove their personal lock from the group lockbox.

This is an example of terminology used by one company

Responsible Person Example



CRH Tarmac Cement and Lime
Safety Procedure



3: Energy Isolation

Section 2: Areas Competent Contractor Authorised For

Complete as appropriate

Authorised For	AI	Induction Period Competed	Role Competency Completed	Site Specific Training Completed	Record of Isolation Training
	Y/N	Y/N	Y/N	Y/N	Y/N
Permitted to operate High Voltage Local Isolators up to 3.3KV					
Permitted to perform Electrical Isolations					
Simple Isolation					
Ensure authorised AI are fully aware of the hazards involved and comply with the Tarmac Cement and Lime Energy Isolation Procedure					

Section 3: Specific areas/MEP authorised:

I _____ (name), Head of Electrical/Maintenance/Production Manager (delete as appropriate) authorise _____ (employee name) to work on the following:

Area	Type of Equipment

Declaration

Signature (Department Head)	Name (Department Head)	Job Title (Department Head)
Signature (AI/RP, delete as appropriate)	Name (AI/RP, delete as appropriate)	Job Title (AI/RP, delete as appropriate)

Third Party Coming onto Site

Sites may regularly have third party individuals coming onto site. This may include specialists such as a British Telecom Representative or an individual coming on site to offer a quote.

These third party individuals may not be Authorised Persons or isolation controllers, but when isolating equipment they also need to attach their own padlocks as issued to them by the business.

In these cases, whilst they won't need to go through the same training as authorised persons, appropriate records must be maintained so as the isolation procedures on site are being properly adhered to.

This is an example of terminology used by one company

Questions every site should ask:

- What activities on site require an company-authorized Responsible Person?
- Does the site have enough Responsible Persons to practically meet the isolation needs?
- Are contractors and direct employees put through the same criteria to be classified as Responsible Persons?
- Does the training to become an Responsible Person have a clear practical element to it?
- Does the training to become an Authorised Person have a clear no-nonsense assessment to it?
- How often is training renewed?
- What additional resources are available to support and improve the skills and knowledge of the Responsible Person?
- What records can the Responsible Person use to show proof of training to other site? Can this record be updated by individual sites as they induct each Responsible Person?
- Is it clear when an isolation controller is required to isolate rather than just a Responsible Person?

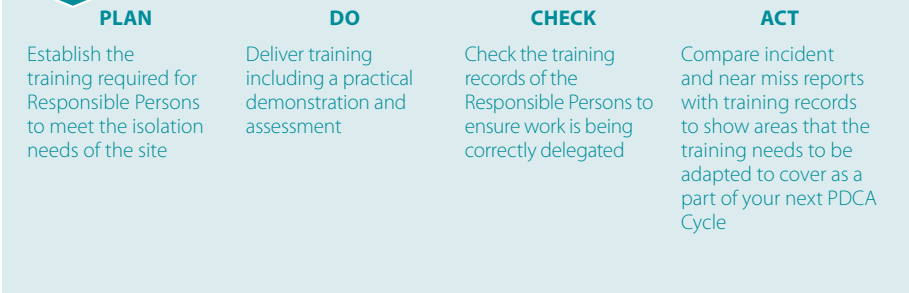



Plant: Safer by Design

Principles

Basic principles should be considered at the design stage of the machinery.

The principles of contact with moving machinery and isolation cover three areas, starting with design and ending with day-to-day operation.

1. Basic Safety Principles, which are implemented within the design of the machinery and should be considered by procurement and operatives alike. These Basic Safety Principles need to be fundamental to the working of the machine throughout its entire lifespan. The aim of building these principles into the design of the machine is to eliminate the hazard, thus removing the need for additional safety principles.

The MPA highlights the Basic Safety Principles for many of the industries standard pieces of machinery in the Safer by Design tool. This can be utilised by any procurement team or individual to ensure that they are purchasing safe machinery without having to incur the cost of actively retrofitting safeguards which should come as standard. An example of these basic safety principles can be found in the Toolkit associated with this guidance.

2. Generic Safety Principles, which focus on one element of risk but can safeguard against that risk across a range of machinery. These principles are implemented when it is not practicable to eliminate the hazard in the design of the machine.
3. Specific Safety Principles that are relevant for specific types or makes of machinery, which need to be accounted for in the awareness, training and behaviours of the operatives of these machines (for example, safety distances, surface temperature, noise). These principles are essential when risks remain despite safe design measures and the adoption of generic safety principles as human behaviour can overcome other safety principles.

ISO 12100:2010(E)

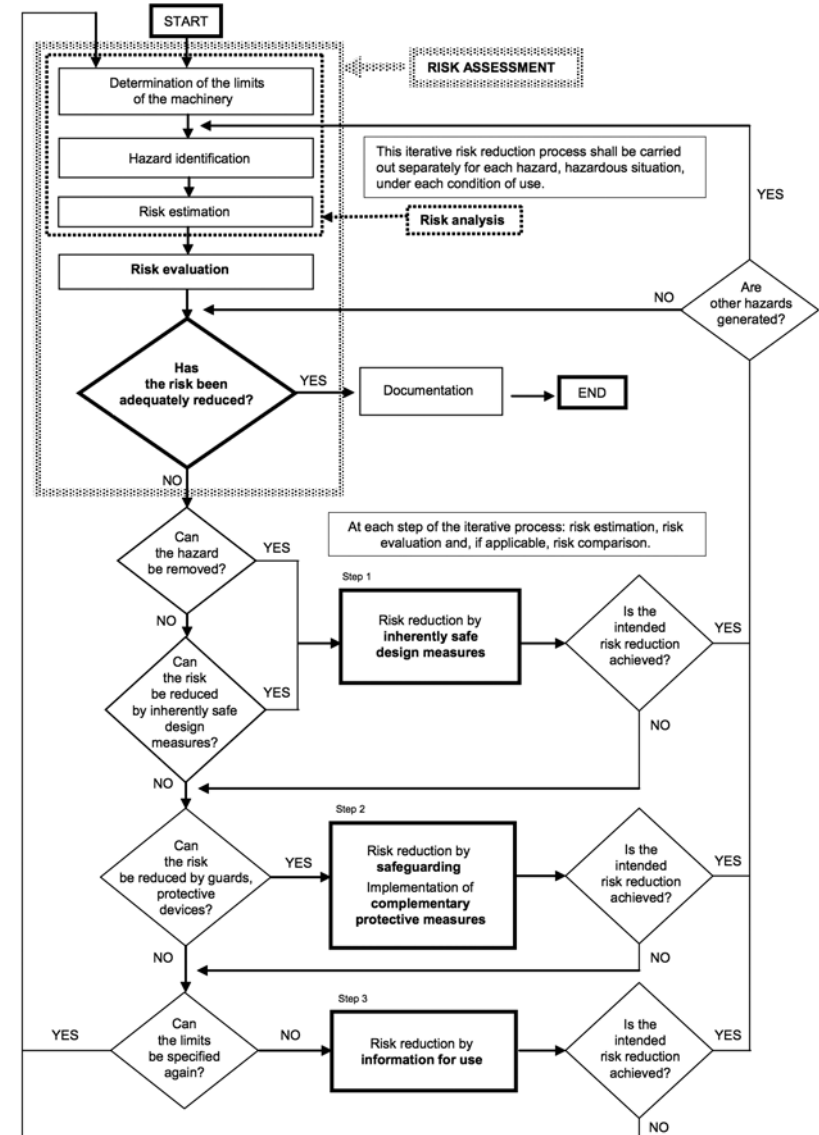

^a The first time the question is asked, it is answered by the result of the initial risk assessment.

Figure 1 — Schematic representation of risk reduction process including iterative three-step method

Guards and protective devices must be used to protect persons whenever an inherently safe design measure does not reasonably make it possible either to remove hazards or to sufficiently reduce risks. Complementary protective measures involving additional equipment (for example, emergency stop equipment) may have to be implemented. Guarding needs to be directly related to the risk profile of the equipment it is guarding.

The following generic safety principles, ranked in the order that they should be implemented, must be in place to protect all dangerous parts of machinery:

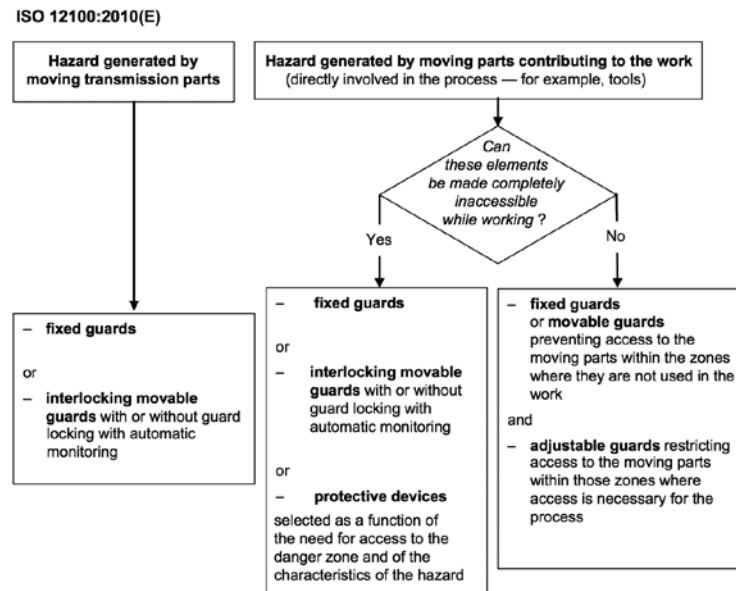

Figure 4 — Guidelines for choosing safeguards against hazards generated by moving parts

- Close-fitting guards: Wherever possible, machinery should be close guarded to prevent personnel being able to work inside the guarded area.
- Other guards or protection devices, such as interlocked distance guards, pressure mats and induction loops: Where machinery cannot be close guarded, a suitable electrically interlocked perimeter guard should be fitted where possible. This should be applied along with an isolation and lock-off process so that no one is able to enter the guarded area unless they have locked out and tagged out.
- As technology advances, this gives businesses opportunities to explore a wider range of control measures such as sensory protection measures. Rather than covering a wide range of machines as guarding does, sensory protection measures need to be applied where they would be of the most use. Types of sensory protective equipment include:
 - light curtains
 - scanning devices such as laser scanners
 - pressure-sensitive mats
 - trip bars or trip wires.

Alternative Safeguards

Provisions should be made to facilitate the fitting of alternative types of safeguards on machinery in order to protect against additional hazards identified in the risk assessment.

Noise

Additional protective measures against noise include:

- enclosures
- screens fitted to the machine
- silencers

Vibration

Additional protective measures against vibration include:

- vibration isolators, such as damping devices placed between the source and the exposed person
- resilient mounting
- suspended seats

Hazardous substances

Additional protective measures against hazardous substances include:

- encapsulation of the machine (enclosure with negative pressure)
- local exhaust ventilation with filtration
- wetting with liquids
- special ventilation in the area of the machine (air curtains, cabins for operators)

Full list can be found in the BSEN 12100 risk assessment

Manual control principles

Manual control devices such as emergency stop buttons or pull cords must be designed and located in an ergonomic and practical position.

The MPA has seen many examples of severe incidents, including fatalities, where the emergency stop control was inaccessible even though it was fitted to the machinery.

When you hit the emergency stop the machine should be brought to a safe condition.

Complete your PUWER Inspections

What is PUWER?

The Provision and Use of Work Equipment Regulations (PUWER) (formerly known as PUWER 98) came into force on 5 December 1998. The main objective of PUWER is to ensure the provision of safe work equipment throughout the lifetime of its use, regardless of its condition, age or origin.

Who's responsible?

Every employer is required to assess the risks to the health and safety of people in their workplace. The regulations not only require employers to provide suitable and safe work equipment and machines, but also to consider working conditions and any risks to the health and safety of personnel. This includes providing appropriate training. To find out more on responsibilities, [click here](#).

What does PUWER apply to?

PUWER applies to the provision and use of all work equipment and machinery; in short, anything from a tool to a single machine to a crushing, sorting and bagging plant.

PUWER and CE marking

As the word 'Provision' implies, a PUWER assessment should be conducted on new machinery before it is put into use. New machinery in the UK should be CE marked by the manufacturer or supplier, even if the machinery has been designed and built in-house for the company's own use. Bear in mind that the CE mark only indicates a claim of compliance and not all suppliers are as diligent in their CE marking procedures as others. A PUWER assessment of a new machine will often highlight areas of non-compliance against the relevant BS EN ISO Standards, so a close inspection of the machine, including the guarding, is essential.

PUWER Inspections/Assessments Common Sense or Competence: What to look for

The following is not an exhaustive list of points to examine during a PUWER inspection, but it provides some tips for things to look for in relation to machine guarding, based on experience of what is commonly missed by people who are unfamiliar with machine guarding inspections.

When carrying out a periodic PUWER inspection, it is important to check that any guards that have been removed for maintenance have been replaced correctly

and that all of the fasteners have been used (if they have not, it may be possible to access dangerous parts of the machine through the resultant gap). Another common issue is that the interlocks on movable guards are defeated so the machine can be operated without the guards being closed. Elsewhere, parts of machine casings (which can provide a protective function by preventing access to dangerous parts) may be cut away so that the machine can be adapted or upgraded, and the modification may result in dangerous parts becoming accessible. If perimeter guards are installed, checks should be made that they have not been moved closer to the machine (perhaps to widen a gangway or install other equipment), nor that the machinery has been modified without the safety distances being confirmed against the requirements in BS EN ISO 13857 (Safety of machinery. Safety distances to prevent hazard zones being reached by upper and lower limbs). Another problem that can arise with perimeter guards is that anything installed outside the guarding – such as low-level barriers to prevent damage from forklift trucks – could be stood on, enabling a person to reach dangerous parts of the machine. If this is considered likely, the height of the guard might have to be increased accordingly.

Frequency of Inspection

Regulation 6 of PUWER requires that where the work equipment is exposed to conditions causing deterioration that is liable to result in dangerous situations, it must be inspected at suitable intervals in order for any deterioration to be "detected and remedied within good time". The findings of these inspections and any resultant actions taken must be recorded until at least the next inspection.

Equipment must be fully inspected and tested at installation and prior to first use in order to ensure it has been installed correctly and is safe to use. A regime of future inspection and maintenance must then be put in place in accordance with PUWER and any other applicable or specific machinery legislation, e.g. power presses, taking into consideration risk assessment findings and manufacturer recommendations in terms of equipment inspection and maintenance intervals.

It is difficult to justify not carrying out re-inspections as this relies on total confidence in the inspection and maintenance processes. It also relies on robust change-management procedures to ensure appropriate PUWER inspections are triggered for any new or transferred work equipment.

Best Practice Principles

Questions every site should ask:

- Have the hierarchy of controls been implemented?
- What can be learnt from incidents within the business or industry to inform best practice when setting basic principles?
- Are the current equipment standards enough to keep employees safe in the case of an emergency?
- What lessons have been learned from previous or existing equipment to better inform future purchasing decisions?
- How are specific safeguards trained out and communicated to operatives users?
- Can manual safeguards be upgraded to “smart” safeguards to prevent against human error?
- How does the business influence safe behaviours to prevent safeguards from being ignored or defeated?

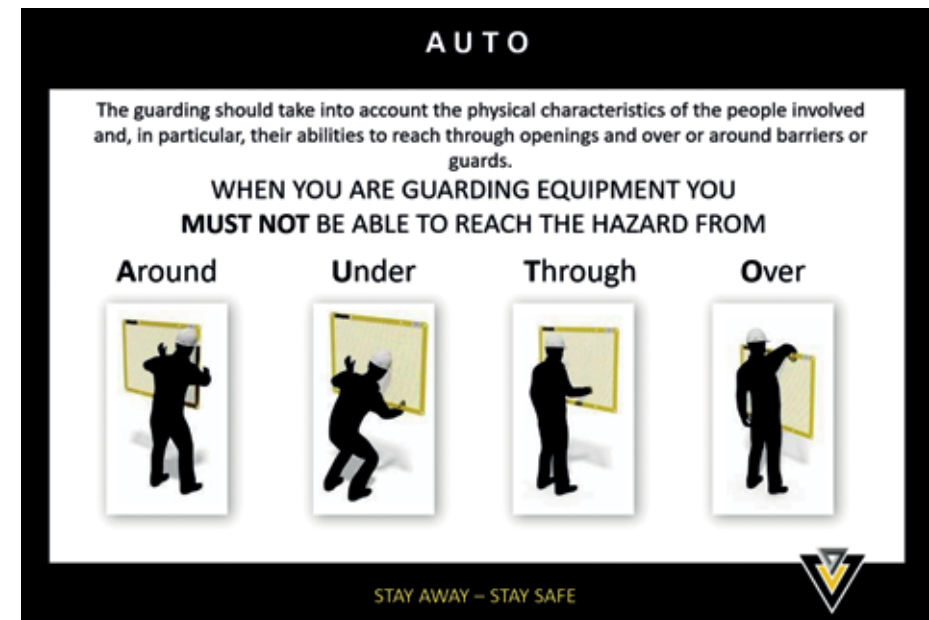

Purchasing

Many companies find that upon purchasing equipment, vehicles and machinery, there is still a necessity to retrofit safety features including guarding. This retrofitting adds cost as well as time before the equipment can be used. The MPA supports the “Safer by Design” approach which aims to ensure equipment is designed and purchased with the correct safety features right from the start.

The best way to provide consistency of quality on these safety features is to follow the standards. Standards can exist at many levels and include:

- International standards (prefixed by “ISO” or “EN”, sometimes by both)
- National standards (eg British Standards prefixed by “BS”)
- Industrial/sector standards
- Even in-house standards



The standards are agreed, repeatable way of doing something. They should be documented, including technical details that designers and manufacturers can refer to. If a supplier is not aware that a business is having to retrofit safeguards after purchase, they won't be able to accommodate these changes in their original designs. The same standards can then be referred to by customers and end users when specifying products, as well as authorities when checking product compliance, particularly where the use of a standard is listed in the Declaration of Conformity or the technical file.

The British Standards Institute link to external website BSI is the UK's National Standards Body. In many cases standards are double prefixed “BS EN” which means this is the UK version in English of a European harmonised standard (in some cases the prefix may be “BS EN ISO” where an international standard has been adopted by Europe as a European standard).

CE Markings

One way a company can ensure that vehicles and equipment are meeting the minimum requirements is to follow the CE mark.

The CE marking is required for many products. It shows that the manufacturer has checked that these products meet EU safety, health or environmental requirements, and is an indicator of a product's compliance with EU legislation.

By placing the CE marking on a product a manufacturer is declaring, on his sole responsibility, conformity with all of the minimum requirements to achieve CE marking. The manufacturer is thus ensuring validity for that product to be sold throughout the EEA. This also applies to products made in third countries that are sold in the EEA and Turkey.

CE marking does not mean that a product was made in the EEA, but states that the product is assessed before being placed on the market. It means the manufacturer has checked that the product complies with all relevant essential requirements, including health and safety requirements.

CE marking is mandatory, but only for those products that are covered by the scope of one or more of the New Approach Directives, which cover machinery, equipment and plant.

The CE mark highlights that a product meets the minimum safety requirements. Businesses have an opportunity to raise these standards through their purchasing decisions, and indeed have a duty to where the risk assessment reveals higher levels of risk.

CE marking is a minimum



Questions every site should ask:

- Has “Safer by Design” been referred to, to follow best practice when sourcing and procuring equipment?
- Are the procurement individuals made aware of the safety standards each piece of equipment requires?
- Are records of the safety features accessible by operatives; health, safety and environment teams and procurement to aid communication?
- Are the same procurement standards applied to necessary additional safety features, such as guards, which may need to be fitted retroactively?
- Does all of the equipment on site have a CE mark if it requires one?
- Do the sites suppliers commit to the standards of CE marking?
- What are the requirements for CE marking for each piece of equipment on site?
- Are there any instances where CE marking standards can be improved upon?
- Have the purchases checked the ‘Declaration of Conformity’ or ‘Certificate of Incorporation’ as well as any other certification that comes with machinery and equipment?
- Has the business purchased equipment that eliminates hazards as a priority?

**PLAN**

Research the rules surrounding the CE mark to establish which equipment requires it

DO

Base procurement and purchasing decisions on the CE standard utilising “Safer by Design” to raise the minimum standards

CHECK

Check all new equipment conforms to CE standards and complete audits for maintenance against these standards

ACT

Develop areas for improvement, focusing on continuous improvement for future purchasing and maintenance standards on site



Common Guarding Standards

Guards should be fitted based on the risk profile of the equipment and the access required. Whichever type of guarding is found to be the most appropriate, there are some common standards that all guards need to adhere to:

- Robust construction
- Use of sound materials
- Be suitable for the conditions in which they are used
- Allow moving machinery to be seen where necessary
- Avoid the introduction of additional risks
- Guarding should be designed to prevent employees bypassing or defeating the protective devices
- Be designed, located and installed to ensure that access is prevented by any person, their body parts or clothing.

Follow the appropriate standard relevant to the identified piece of equipment.

NB: Where guards are fitted to the underside of conveyors there may be a risk of spillage accumulating within the guard. In such situations, the guard mesh should be of a size sufficient to allow spillage to fall through (where safe to do so) whilst preventing access to the moving parts within the guard.

Fixed Close Guards

- Must be held in place by fastenings that require a tool to release them. This excludes cable ties and wire or other such bindings
- Where possible, the fixed guard should not remain in place once their fastenings are removed.

Perimeter and Distance Guards

- Guards should be secured to a solid foundation or adjacent structure
- Be equipped with a suitable interlocking device to prevent moving parts starting up whilst those parts can be accessed. Electrical interlocks must be on mains voltage, not control voltage.

All Guards

- Where possible, to be installed to allow routine adjustment and maintenance of the guarded machinery without the need to remove the guard (e.g. remote greasing points, external adjusters for tracking). If this is not possible then a strict safe system of work should be enforced
- Be subject to an initial commissioning examination and subsequent routine inspection regime to ensure they are - and remain - fit for purpose.



PLAN	DO	CHECK	ACT
Use Safer by Design to establish hazards that can be eliminated	Inform procurement of hazards identified in the PLAN stage	Check retrofitted safeguards are appropriate, including opportunities to improve either specific or sensitive controls	Produce an upgrade and maintenance schedule in line with principles and in order of highest to lowest risk factors

Questions every site should ask:

- What equipment is on site that requires guarding?
- Where are close fitting guards required?
- If close fitting guards cannot be utilised, what other innovations can be taken advantage of to prevent an incident?
- Are there any areas on site that require guarding to provide protection from hazards e.g. hot temperatures or falling materials?
- Where machinery cannot be guarded, what other safety features are in place to prevent injuries?
- Is the correct isolation process implemented before guarding is removed?
- Is there a robust maintenance schedule in place to keep the guarding in the best condition?
- Is guarding under conveyors appropriate for clearing debris?
- Are near misses completed when guarding is in a poor condition, broken or missing?



PLAN	DO	CHECK	ACT
Develop an audit highlighting all of the guarding requirements on site	Audit all guarding ensuring missing, broken or inadequate guarding is recorded and made immediately safe	Discuss with operatives the results of the audit to check no guarding requirements have been missed	Put together a schedule ensuring all inadequate guarding is rectified in order of risk

Best Practice Safer by Design

Safer by Design is an MPA product that is aimed at reducing injuries and ill-health attributable to poor mobile and fixed plant design.

Research has shown that even though meeting international safety standards and the requirements of the EU Machinery Directive, a significant proportion of incidents involving mobile plant and machinery on mineral producing and processing sites are due to poor design.

A new fixed plant criteria will complement the current mobile plant checklists, which can be found at www.safequarry.com/home/safer-by-design.aspx



Home

LOADERS
BULLDOZER
EXCAVATORS TRACKED
EXCAVATORS WHEELED
DUMPTRUCKS ARTICULATED
DUMPTRUCKS RIGID
MOBILE CRUSHERS AND SCREENS
MACHINE INDEX



Home

Access Systems
Visibility
Safety & Security
Maintenance
Environment & Health
View all options
MAKE TEXT BIGGER

LOADERS

UPDATED 2012

MACHINE SIZE

S	M	L
---	---	---

CHECKLIST FOR MY PLANT

Access Systems
☑ = core
☑A = core aspirational
OPT or OPT↑ or OPT↓ or OPT↑A = optional
?
📷
🖨️

Steps (All Machines)						
1	If more than two steps, access by an incline system (i.e. with an angle of inclination from the horizontal no greater than 75 degrees)			✓	✓	✓
2	First step to be rigid			✓	✓	✓
3	First step to be no more than 300mm off the ground			✓A	✓A	✓A
4	At least the steps likely to be damaged (for machines intended use) must be retractable out of harms way			✓A	✓A	✓A
5	Powered retractable steps external alarm to give prior warning of activation			✓	✓	✓
6	All risers to be of consistent height and of consistent inclination between landings			✓	✓	✓
7	Primary access system and cab door to be lit, if cab platform height is >2m			N/A	✓	✓
8	Primary access system and cab door to be lit			OPT↑	N/A	N/A
9	Light activation shall be from ground level and cab, with manual switch off			OPT↑	✓	✓
10	Light activation shall be from ground level and cab, with auto switch off			OPT↑	OPT↑	OPT↑

BACK TO TOP
PRINTER FRIENDLY VERSION

Plant and Equipment

The plant and equipment, which is essential for the successful running of the business, will increase risk of harm to employees. Knowing this, it is important to carry out risk assessments that determine the levels of control required.

In some cases, this may mean upgrading or changing the equipment to a more modern safety standard, whereas in other cases, protective equipment such as guarding can be retrofitted to reduce the risk.

Guarding alone does not guarantee safety. It must be:

- Appropriately designed and fit for purpose
- Meet the requirements posed by the risk highlighted in the risk assessment
- Installed by a competent person
- Checked before plant and equipment is worked upon
- Cleaned and maintained on a regular basis
- Inspected as a part of site evaluations

Some plant and equipment cannot have the risk removed or reduced, therefore the business needs to instill a sense of responsibility and accountability through safe working processes and visible leadership e.g. appraisals.

Questions every site should ask:

- What plant or equipment is on site and what risk does it pose?
- Is equipment and plant being used for the job it was designed for?
- How does plant and equipment need to be guarded and what is the standard?
- What is the maintenance and cleaning schedule for the plant and equipment that is on site?
- Is there an inspection of the plant and equipment on site and who performs this?
- Can you sample material safely from the conveyor?
- What are the risks with moving conveyors?
- Are there any blockages that happen on your conveyors and how do you unblock them?
- Are any of your guards secured by zip ties instead of nuts and bolts?
- How are defects with plant or equipment reported and rectified?
- Are there areas on site where equipment, plant and mobile plant should be segregated from human contact?
- What is the process for decommissioning plant or equipment once it reaches the end of its life?

Plant and Equipment - Head Drum Guarding

Guards should be provided to prevent access to head drums and all associated nip points.

A **Nip Point** is the dangerous pinch point that occurs at the line of contact between the conveyor belt and rotating pulley, and in certain cases between belt and idler roller.

Sometimes a point only has the potential to be a nip point based on the load, tension of the belt or belt direction.

All nip points must be guarded. Some nip points have the potential to drag people in.

The distance from the guard end to the centre shaft of the head drum should be sufficient to allow material to fall without damaging the guard and protecting the in-running nip. Where troughing idlers are positioned close to the head drum and place the belt under tension, the guard should be extended at least a further 1000mm beyond such idlers.



Tail Drum Guards

Guards should be provided to prevent access to tail drums and all associated nip points. The distance from the guard end to the centre shaft of the tail drum should be a minimum of 1000mm. Guards should be provided on the underside of the conveyor to prevent access to the return nip of the tail drum.

All guards should be designed such that lubrication and adjustment can be carried out without removing the guard.

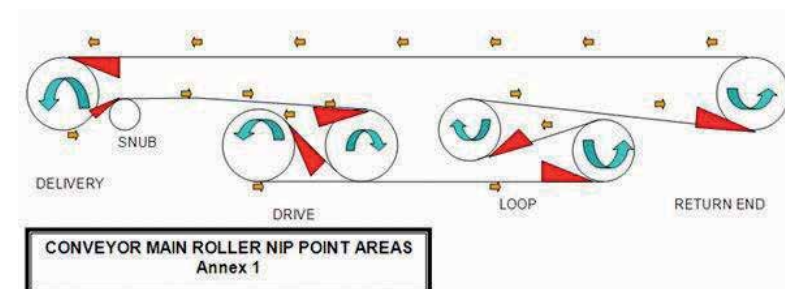

Skirting Guards and Batch Feeder Belts

Skirting Guards

In situations where fixed skirts are fitted above conveyor idlers, a trap point exists between the idler and the belt. Panels of guards should be fitted to prevent access to the trap points associated with the skirts of the conveyor.

Batch Feeder Belts

Batch feeder belts, whilst generally slower, possess the same hazards as a normal conveyor.

The feeder and all associated nip points should be enclosed within suitable mesh guards fitted along the full length of the feeder. Guards should be provided on the underside to prevent access to tail and head drums.

Guards should be designed such that routine maintenance and adjustment can be carried out without removal of the guards.



Return Rollers

Conveyor return rollers do not generally present a nip hazard. However, in the following situations a trap hazard exists:

- Where the belt cannot freely lift sufficiently it presents a nip point because a structure is positioned above the belt.
- Where a tensioning roller has been positioned on the upper side of the return belt, the belt is under tension and several nip points are created.

There are varying types of guard available to guard nip points relating to return rollers:

- Plate type guards can be fitted along the full length of the roller in front of the in-running nip point. Measures should also be taken to prevent access to the nip from each side of the roller.
- A suitable open mesh guard can be provided to totally enclose the roller. The guard should be of robust construction with a mesh of sufficient size to prevent the accumulation of spillage within the guard and yet prevent finger or hand contact with the trap points within.



Belt Tension Points and Gravity Take-Up Unit (GTU)

Belt Tension Points

Where a conveyor changes angle such as is shown in this picture, a series of nip points is created. These will draw a person in if they become entangled and could result in a fatal or major injury. These points must be guarded properly to prevent this from happening.

Gravity Take-Up Unit (GTU)

Conveyor gravity take-up units should be enclosed with perimeter guarding using mesh panels manufactured to the correct BSEN standards, (see appendix) which prevent access to moving parts within the tower including the risk of the gravity take-up weight falling to ground level in the event of the belt breaking. All panels should be secured such that they require a tool for removal.



Snub Drum Conveyors

Conveyor Snub drums and pulleys are generally situated on the underside of a conveyor directly behind the head drum and serve the purpose of providing a maximum contact area between the drum and belt. Trap points exist between the underside of the belt and the in-running nip of the drum.

A suitable open mesh guard should be provided to prevent access to the in-running nip of the belt and drum from the underside of the conveyor and each side. The guard should be of robust construction with a mesh of sufficient size to prevent the accumulation of spillage within the guard and yet prevent finger or hand contact with the trap points within.



Screw Conveyors and Dewaterers

Screw Conveyors

Where screw conveyors are provided with inspection covers, all covers should be secured with fastenings that require a tool for their removal. Exposed rotating shafts and motor couplings on either end of a screw.



Dewaterers

Fines dewaterers use slowly rotating scraper blades to extract the finer particles. In addition to a sheet metal guard on the main dewatering section, a mesh guard should be provided around the trough of the scraper blade section. This should be fitted high enough to avoid personnel falling into the trough or being able to reach the scraper blades and be at least 2 metres above ground level.



Concrete/Readymix Plant

Pan mixer with fibre hatch and interlock system

The mixer top door should be provided with a suitable electrically interlocked device to prevent the cover being opened unless the electrical power is disconnected. However, full isolation of the mixer should be undertaken (LOTOTO) when working on the hatches on the mixer. Inspection hatches on the mixer cover should be provided with secondary grids to prevent contact with the moving paddles within, when the mixer is in operation.



Mixer Discharge Chutes

A guard manufactured from sheet metal with a hinged mesh access cover should be provided to prevent access to the moving parts of the mixer discharge. A tool or interlock should be required for its removal. Where appropriate, lifting eyes should be attached to the pan mixer lid.



Guarding Motors

V-Belt drives are commonly used on various items of equipment on process plants. Open mesh guards enable more efficient cooling of the V-Belt and pulleys and allow V-Belt tension to be visually checked without removal of the guard. Alternatively, you can enclose the drive with a guard manufactured from steel sheet. Where joints are necessary for easy removal of the guard, sections should be joined by flat metal or angle iron welded to each section and drilled to secure the bolts. Gaps at the point where shafts enter the guard (which may be necessary for adjustment) should be kept to a minimum.



Feed Hoppers

Steel grids, to prevent unauthorised or inadvertent entry, should be provided in the top of all process plant feed hoppers (with the exception of primary dump hoppers or where products of a large dimension are being processed, which may obstruct the grid). The grids should be secured in such a manner that they require a tool for their removal. The aperture size of the grid should be designed to enable process material to pass through and be of sufficient strength to withstand any anticipated loads.

Points for Consideration:

- If access hatches are built-in, BOLT THEM.
- Grids fitted on elevated hoppers may encourage people to walk on them next to an unprotected edge. Sign accordingly.
- Storage bins do not normally have protective grids, but where they are fed direct by loading shovels, grids should be considered. Where such bins cannot be easily accessed and it is not practical to fit grids.
- Fit clear signage prohibiting access without a Permit to Work (UKCP49).



Skips

Hot Storage Skip Winch (sited at ground level)

A mesh panel guard fence should surround the mechanism and be securely fixed to the structure or foundations. An access gate will be required, which should be secured by means of a suitable electrically interlocked system.



Skip Loading Point Distance Guarding

A mesh panel guard fence should surround the mechanism and be securely fixed to the structure or foundations. An access gate will be required, which should be secured by means of a suitable electrically interlocked system.



Primary Crusher Guards

Drive Guard - Primary Jaw Crusher

Guards can be either manufactured from mesh or steel sheet. A mesh guard should totally enclose the drive, with the outer section manufactured from steel sheet. Where joints are necessary for easy removal of the guard, sections should be joined by flat metal or angle iron welded to each section and drilled to secure the bolts. Gaps at the point where shafts enter the guard (which may be necessary for adjustment) should be kept to a minimum. Consideration should be given to manual handling requirements when maintenance is being carried out.

The provision of lifting attachments should be considered where mechanical means of lifting may be required. Similar guards will generally be provided to enclose the flywheel on the opposite side to the crusher drive.

Primary Jaw/Toggle Plate Guarding

A guard panel is required to prevent access to the area immediately behind the crusher swing jaw where movement of the jaw presents a trapping hazard between the jaw and the crusher frame.



Screens, Vibrators and Fly Wheels

Guarding over Resonance Type Screens and Vibrators

Totally enclosing sheet metal guards should be provided over each of the vibrating units, with additional sheet metal guards over the associated shafts and couplings.



Vibrating Screen Vee Belt Drive and Flywheel Guards

Drive guards with mesh sides and sheet metal around the guard should be provided. In addition, a sheet metal guard should be provided to enclose the flywheel.



Asphalt Plants

Asphalt Mixer driven by direct drive from two electric motors

A fixed guard is required to enclose the drive shafts and flexible couplings connecting the electric motors to the mixer shafts.

Mobile Asphalt Dryer

Panel type guards need to be securely fastened to the main dryer chassis on both sides and running the full length of the dryer cylinder. The guards should be attached such that a tool is required for removal. Guards should extend upwards as a minimum to the centre line of the cylinder. Measures must be taken to prevent access to moving parts of the machine from underneath the chassis. Perimeter Guarding should be installed around the asphalt plant dryer.

Perimeter Guarding

Panel type guards are required, which should be secured to fixed uprights. The minimum height of the guard above ground level should be two metres. All access gates should be secured with a suitable electrically interlocked system. Remote greasing lines should be provided to enable lubrication of bearings to be carried out without entering the guarded area.



Robot Guarding

A fixed perimeter fence should be provided around the working area of the robot. Entry gates into the fenced area should be provided with a suitable electrically interlocked system. Light curtains may be installed as an additional safeguard to protect personnel if they enter the robot's immediate working area.

Entry to Guarded Enclosures around Robots

The teach mode can only be operated by personnel who have received the relevant training from either the robot manufacturer or an authorised trainer. Prior to robot teaching activities, a risk assessment and safe working practice shall be developed and communicated in line with the requirements of UKCP02 Assessment. Where possible and safe to do so, robot teaching activities must be completed from a safe location outside of the distance guarding. If this is not possible, the following gives guidance for robot teaching activities:

- Where there is an intention to use the teach mode from within the guarded enclosure, a suitable and sufficient risk assessment, safe working practice and permit to work must be in place.
- Before entering into a guarded enclosure for teaching purposes, the system must incorporate the facility to "request access" to the enclosure via a control that will park the robot in a safe position, e.g. home or datum point.
- The key exchange system must disable the ability to remove the key until such time as the robot arm has returned to this safe position.
- A facility to enable switching from auto mode to teach mode must be provided within the guarded enclosure. This will be possible with the guarded enclosure access gate open, utilising a sentry to prevent unauthorised access.
- The robot must operate at no more than 10% of its maximum speed in teach mode.

- If the teach mode pendant is to be operated within the guarded enclosure, industry best practice and manufacturer's recommendations must be adhered to regarding safe operating positions.
- The robot shall be fitted with physical (positive) stops on all axis' where practicable. The physical (positive) stops must also prevent the robot extending outside the guarding enclosure where practicable.
- Operation of the teach pendant will disable operation of the robot from any other control point.

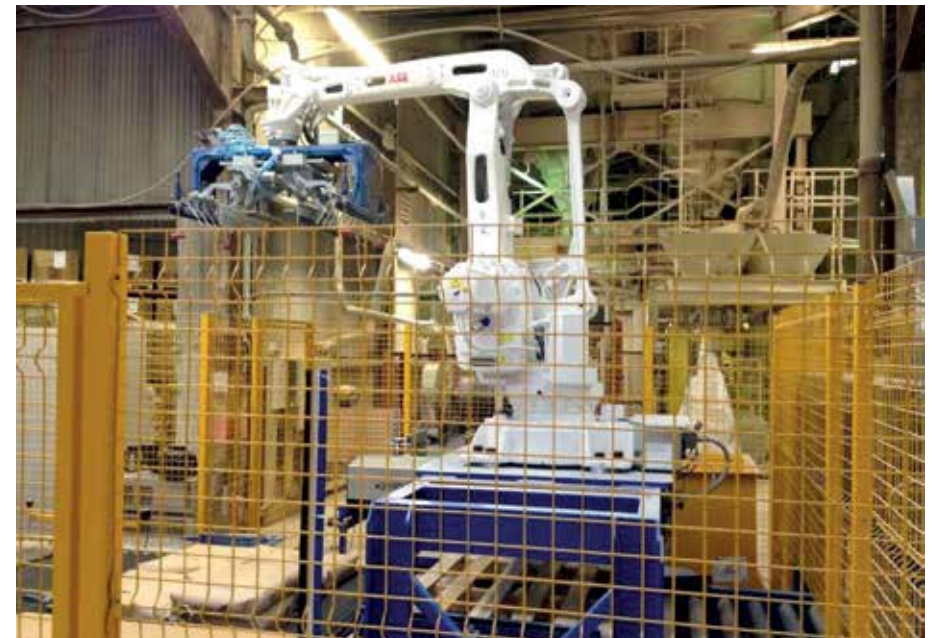

Energy Stored in Plant

As a part of the operational risk assessment, sources other than kinetic (motion) and electrical need to be considered. This is particularly relevant to mobile plant. Whenever mobile plant is left unattended, has workers within its exclusion zones or is being worked upon for maintenance, it must be isolated first. Mobile plant that is not correctly isolated can move or release energy unexpectedly.

Large Goods Vehicle

Electrical energy upon start up

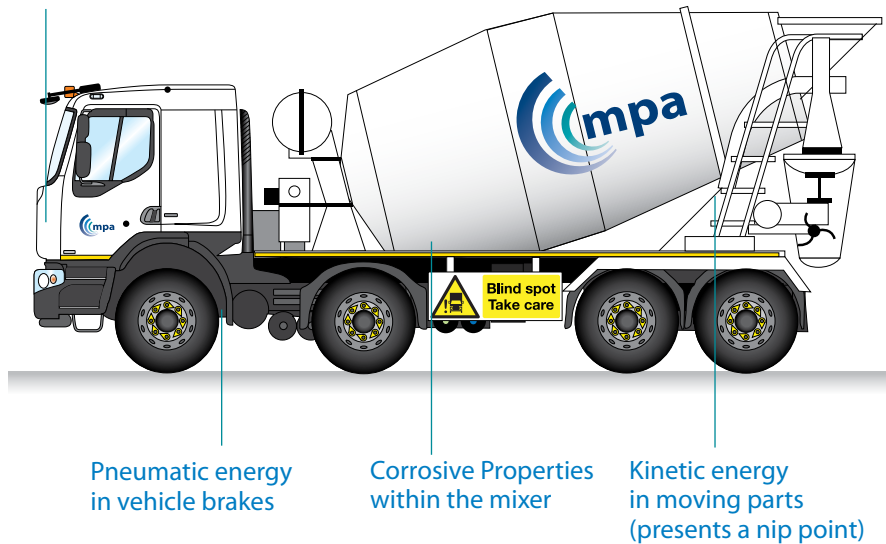

Mobile Plant

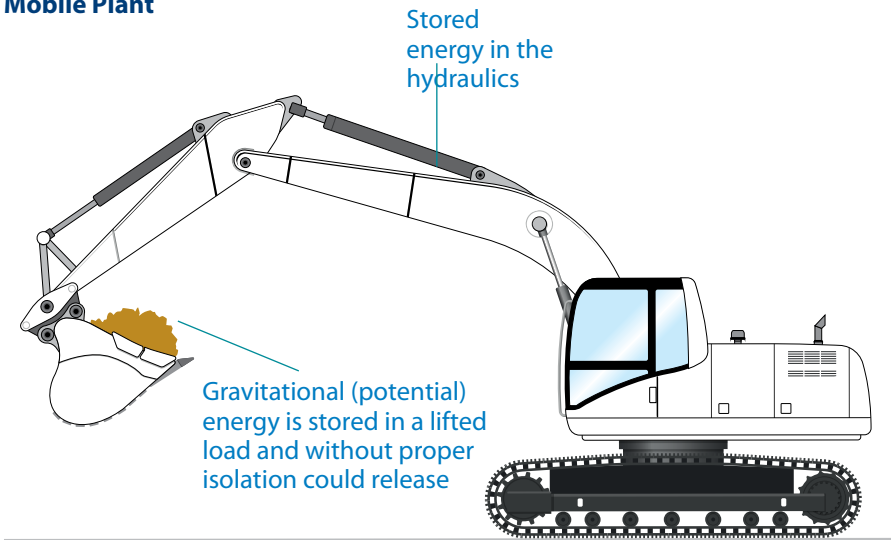

Loading Shovel

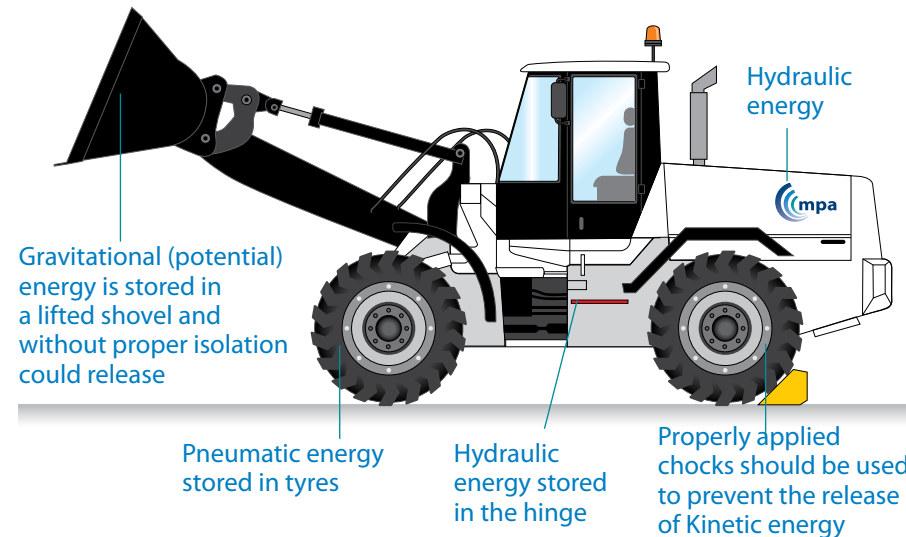

Fixed plant

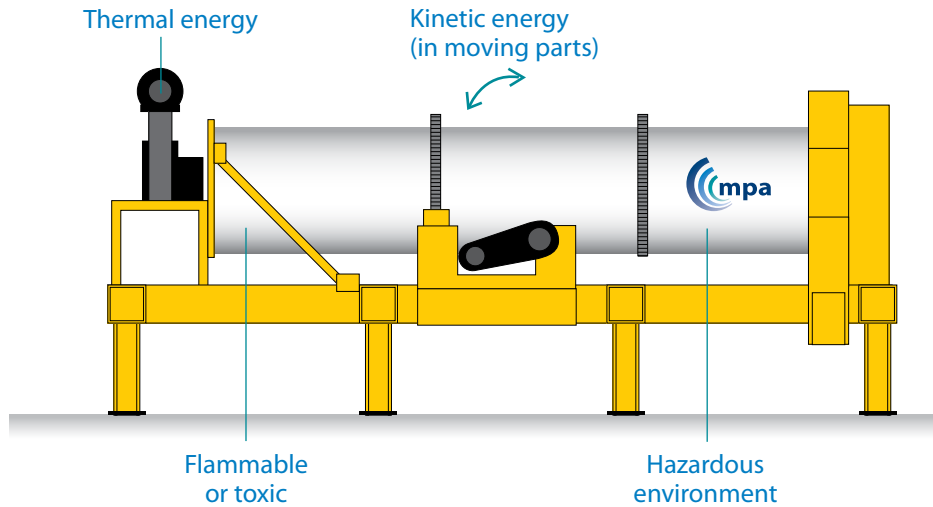

Planer

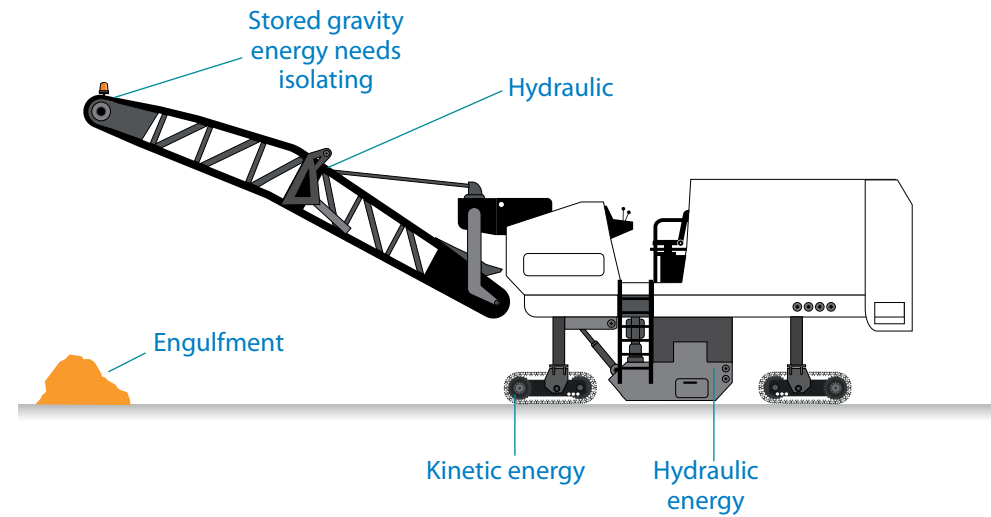

Front End Loader

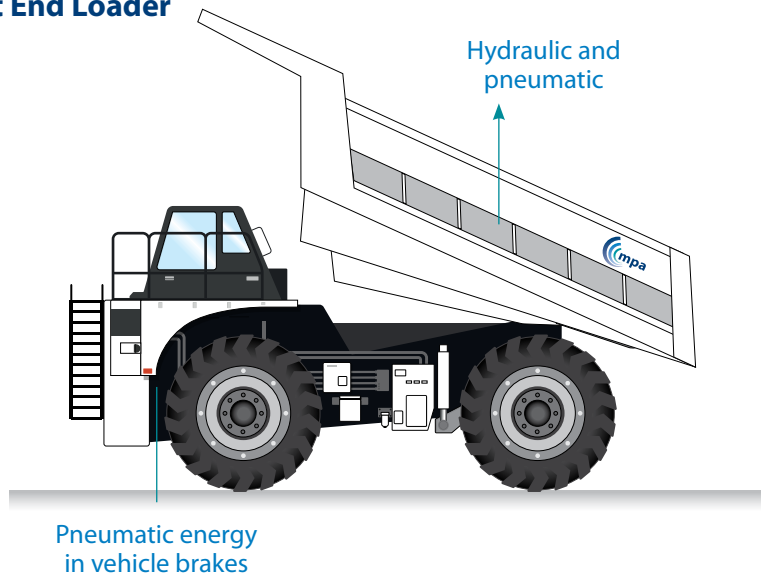

Conveyer

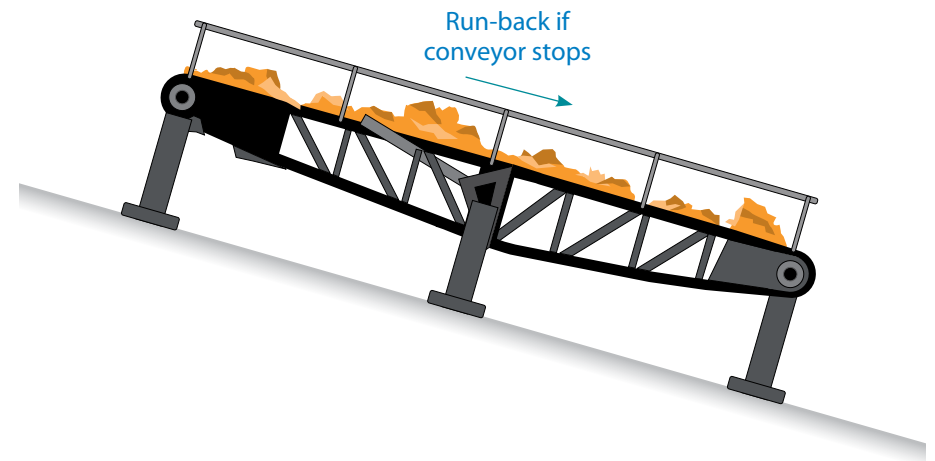

Best Practice Mobile Plant

Questions every site should ask:

- Is all mobile plant safe from acquiring excess energy, e.g. parked on flat ground?
- Is mobile plant kept away from overhead cables or power lines?
- What is the maintenance procedure for mobile plant?
- Is there only one key for mobile plant? If more than one, how is it ensured that the other will not be used without the driver knowing?
- Does the Mobile Plant have ergonomically placed 'Emergency Stop' facilities? Is everyone working with or around the plant fully aware of where these 'Emergency Stop' facilities are placed?
- Can advanced technologies be used to prevent the mobile plant from being left unattended without being locked off?
- Is the plant correctly labelled with the locations of isolation points, valves etc?
- Is redundant plant completely locked off so as it cannot be energized?



PLAN	DO	CHECK	ACT
Establish a full isolation procedure that takes into account all energy sources surrounding mobile plant	Train all employees working with or around mobile plant on all the potential energy sources and how to isolate them	Utilise VFL to gauge the awareness around the importance of isolating mobile plant	Develop a working group to discuss advanced technologies that remove the need for human intervention in order to isolate mobile plant

Labelling/Identification

ISO 7010

Marking and labelling is an important requirement of several standards depending upon the type of energy that is to be isolated. Pipework carrying water, steam, oils, gases, electrical services or ventilation ducts, for example, needs to be labelled according to the BS 1710. Electrical energy, including wiring for electrical equipment, also needs to be labelled as a part of the BS 7671. You should consider permanent labelling for this purpose. All isolation points, including bleeds and spades, should be fully documented to ensure the correct position and sequencing of all the components associated with an isolation scheme (e.g. the position of vents, the removal of physical isolations). This is in addition to full checks on site.

Notices or labels are also required at some of the following points and equipment within an installation:

- Where an unexpected presence of nominal voltage exceeding 230 V is present
- Where there is a presence of different nominal voltages in the same equipment
- Where a bonding or earthing conductor is connected to equipment
- To identify protective devices
- To identify isolators and the circuits which they isolate
- Where isolation requires more than one device
- At the origin of the installation a notice showing the next inspection date
- At each distribution board with a notice warning if there are two wiring colours present

This list is not exhaustive and therefore all labelling should be completed to the standards that the business follows to meet the demands of the risk levels determined at the assessment stage.

Some more complicated plant may need isolation maps in order that a total isolation can be completed with the entirety of the plant in mind. The necessity for this level of labelling will be based upon the risk profile of the plant.

Questions every site should ask:

- Are all isolation points clearly labelled?
- Is the labelling permanent?
- How is the labelling audited and inspected? Who is in control of this?
- Does the labelling follow the correct BS standards, ensuring that anyone within the industry would understand the colour codes and numbering?
- Where are the labels on site documented?
- Does the site have complex isolation networks which need isolation maps as well as labels?
- Does everyone who is responsible for isolation have access to label documentation and maps?
- Is it clear from the labelling how to isolate specific parts of machinery and equipment?
- Are the labels shown clearly, kept clean and free from other signage that could be distracting?
- Is it written in local language?

It is important that the signage correlates with the piece of equipment so that it is clear that it is related to that isolator.

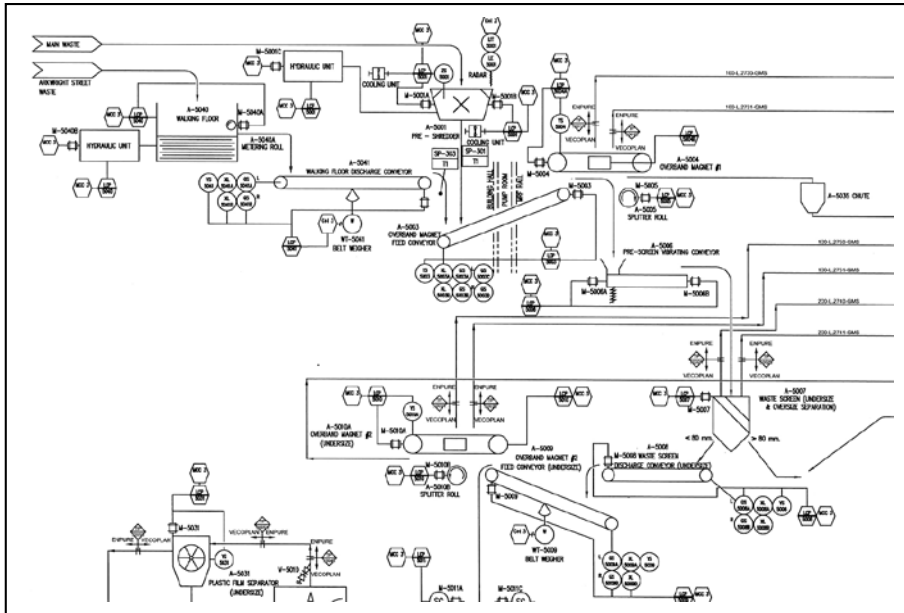

LOCKOUT-TAGOUT PROCEDURE
OSHA CFR 1910.147

Developed by: RA, RA, RA
Reviewed by: RA, RA
Equipment #: 182036
Location: South Utility Building | Area: Utilities
Rev: 0 | Date: N/A | Origin Date: 10/2017

5 Isolation Points to be Locked and Tagged

NOTE
Only shut down Air Compressor #1 when Air Compressor #2 is fully operational. Shutting down both compressors will affect facility operations.

REVIEW NEXT DATE: JAN 2018, JAN 2019, JAN 2020, JAN 2021

South Side View, North Side View, West Side View

ALWAYS PERFORM A MACHINE STOP BEFORE LOCKING OUT DISCONNECTS

ID	Source	Device	Location	Method	Check
1.1.1	Electrical 480V	Pushbutton	Isolation point located on MCC-L7274B.	Move electrical disconnect "Air Compressor #1" to off. Lock out.	Attempt restart at CP-1.
1.1.2	Electrical 480V	Pushbutton	Isolation point on North side of unit.	Move electrical disconnect to off. Lock out.	Attempt restart at CP-1.
1.1.3	Pneumatic Outlet - 120 PSI	Gate device	Isolation point located above unit.	Turn valve to closed position. Lock out. Open bleed valve.	Visually verify zero-pressure status.
1.1.4	Cooling Water Inlet - 40 PSI	Gate device	Isolation point on North side of unit.	Turn valve to closed position. Lock out.	Visually verify zero-pressure status.
1.1.5	Cooling Water Inlet - 40 PSI	Gate device	Isolation point on North side of unit.	Turn valve to closed position. Lock out.	Visually verify zero-pressure status.
Thermal Energy 300 F		Be sure to wait until heat has dissipated from machine until cool to touch before servicing. Wear proper PPE before beginning work.			
Kinetic Energy 600 RPM		Be sure to wait until all moving parts have come to a complete stop. If necessary, use a block or chain to prevent equipment from moving while servicing.			

OPENING A GUARD DOES NOT CONSTITUTE A LOCKOUT
Any machine modifications must be shown in procedure. Contact safety department to update procedure.

Safety Is Your Responsibility!

LOTO - Air Compressor Example.xlsx



PLAN

Access the label requirements that equipment and machinery currently has

DO

Ensure that all labelling is up to date, correct, clean and in line with BS requirements

CHECK

Match documentation and isolation maps up with labelling on site to ensure that they match

ACT

Put an inspection program in place which audits the labelling on a regular basis

Isolation Equipment

When Selecting LOTOTO equipment it is recommended that you trial the various devices available to ensure they suit your plant and equipment for which they are to be used, but also to familiarise yourself with the use of these devices. In principle all LOTOTO devices look easy to use, but when on plant it is not always clear and you should always try in a safe environment before in an isolation. It is broken down into several elements:

Padlocks – Ensuring that each employee has a unique safety padlock is the cornerstone of any robust LOTOTO system. It guarantees that only one person can open each padlock, ensuring everyone's safety. It should be UNIQUE and supplied with 1 key, with the unique key number on both the body and key. Typically, safety locks have between 20,000 and 40,000 different keys and the supplier of the padlock records the key numbers to prevent duplication on site.



Hasps – Multi hasps are used when multiple individuals are involved with an isolation and are accountable for their own safety. The function of the device means the energy can't be restored until all padlocks are removed from the multi hasp.

Tags – Lockout Tags are used to display critical information and warn others of potential danger. Various details can be displayed such as: Individual Name, Photos, Contact Numbers, Task Information, Machine State, Expected Duration/Return to Service Date or Job Status. This is local control, which assists the formal task communication in place.



Electrical Devices – These devices are usually used to isolate an individual circuit e.g. MCB, MCCB, RCBO or Fuses. Equipment is also available for portable equipment with a plug ranging from 110V – 415V. Ensure you have sampled the devices you have selected for use on your switchgear or machinery. These devices are designed to stop a switch or control being switched on when under maintenance or shutdown. This includes voltage testers and proving units.



Mechanical Devices - Mechanical Lockout allows you to secure a valve in the OFF or ON position while working is being carried out or a process flow requires the flow to be constant. These devices are used to isolate a mechanical valve or control (e.g. ¼ Turn Ball Valve for Compressed Air, Butterfly Valves for Mixers or Gate Valves for flowing fluids or gas) and are always secured in place using an approved safety padlock. As in our industry the variation of types are infinite, universal devices are available but always advise you check the fit and suitability on plant. Pneumatic lockout gives you the ability to isolate safely without the expense of installing in-line lockout valves.



Group Lockout – Group Lockout is a critical control method where multiple individuals are working on multiple Isolation points. This facilitates the storage of padlock keys from the isolation points, but more importantly each individual working on this task is accountable for their own safety as they will apply a personal padlock to the Lockout Box. This means that without all the padlocks removed from the Lockout Box, the keys for the isolation points would remain in a safe, secure and controlled state. They are available in all formats so you can choose which best suits your application. These are often used to add control to Interlocking systems.



Isolation Stations - Lockout Stations are used to Store equipment centrally or locally depending on how you set your system up. You have to consider your isolation register locations as this is a imperative part of the system. If you have area-specific requirements they can be made bespoke to suit.



Cleaning of Equipment – Like any critical component of your business, you need to ensure it is clean and its operation is not affected. As padlocks are mechanical, they have small internal components and with the industry we are in they do need to be cleaned to ensure no build-up of dust effects its operation. This can be done weekly to monthly depending on exposure and frequency of use. Use specific lock cleaner and not WD40 or Graphite as these have a negative effect.

Questions every site should ask:

- What isolation equipment does the plant and machinery on site require?
- Has the isolation equipment been trialed before full purchase to ensure its suitability on site?
- Does everyone involved in isolation know how to use isolation equipment?
- Does isolation training involve a practical assessment so that all isolators have the opportunity to use isolation equipment outside of a live environment?
- Do all Responsible Persons have a unique padlock with which to isolate? If they require more than one, do they have enough to meet the isolation needs of the site? Additional padlocks assigned to an individual all need to be unique themselves.
- Are mulit hasps required for isolations involving multiple individuals?
- Is all isolation equipment clean and ready for use? Are specific cleaning products required to meet the needs of the isolation equipment in use?
- Are isolation tags clear, clean and legible? Is a standard format used across the site to ensure everyone can understand the information being conveyed?
- Does this site require a group lock-out process?
- Would a lock-out station be an appropriate way to manage the site's isolation equipment?

Best Practice Isolation Equipment



Isolation Methods HS10 / Guidance



The purpose of this guide is to give practical advice on the various isolation methods that can be adopted as part of an Energy Isolation & LOTOTO event.

Specification for Lockout Equipment used for Energy Isolation & LOTOTO Events

Personal padlocks shall be of the following minimum specification:

- All shackles on the padlocks shall not exceed 6mm in diameter,
- Clearly traceable to the employee (ideally named) or individual to whom the padlock was issued by its unique isolation lock id,
- All Contractors' padlocks shall be engraved clearly identifying them, with a 'C' or 'Contractor' along with an ID number and
- The key to the padlock shall be unique with **no** spare keys.



To differentiate the Unsafe MEP/Unfinished Work Padlock from Personal Padlocks they shall be **black** in colour and to avoid any confusion **black** padlocks shall only be used for this purpose.

Multi-hasps shall be of the following minimum specification:

- Able to accept a 6mm diameter padlock,
- All shackles on the multi-hasps shall not exceed 6mm in diameter and
- Be unable to easily open the jaws of the hasp.



Lockout Devices should be provided to enable the secure energy isolation of field equipment such as:

- Plug-in equipment,
- Circuit breakers,
- Fuses and
- Pipework valves.



All lockout devices shall be able to accept a 6mm diameter padlock.

Where the design of the lockout device cannot support the weight of a hasp & multiple padlocks then a single padlock shall be used and the key stored within a lockout key box.



PLAN

Assess the isolation equipment requirements of the plant and machinery on site

DO

Issue a unique padlock to all responsible individuals on site, ensuring they have the opportunity to familiarise themselves with their use before entering live situations

CHECK

Ask employees for their unique padlocks during a walkaround or hazard spot to ensure they are being used only by the individual they are assigned to

ACT

Consider upgrading your system to accommodate electrical or mechanical isolations to remove the human factor when isolating

ISOLATION/PERMIT

5. EQUIPMENT

5.1 LOCAL MOTOR ISOLATORS

These are electrical isolators, with a clearly indicated facility for locking off. Each isolator is positioned close to the drive it controls and is labelled with the description and reference number of that drive.

5.2 MECHANICAL ISOLATION DEVICES

These are valves, blanking plates, etc., which are used to cut off the flow of liquids, solids and gases, and which also have a locking facility.

5.3 PERSONAL SAFETY LOCKS

These are padlocks each with one unique key. There are no duplicate keys, each lock is engraved with an individual reference number.

Personal Safety Locks will be issued, on induction, to each employee who is required to work within the Permit to Work System, and to each regular contractor during his attendance at the "Local Isolation Permit to Work" training course. The reference numbers of the Personal Safety Locks will be recorded against each person's name.

Should a key and/or lock be lost or damaged, a new lock and key will be issued and the records updated.

Personal Safety Locks are used to lock electrical isolators, mechanical isolation devices, and to secure the keys of the locks used for Complex isolations. They must always be applied when work is carried out on items of plant that are required to be isolated.

Each person must fit and remove his own Personal Safety Locks. They provide both a guarantee of personal safety and an indication of the presence of a person in a particular plant area. No person may work under the cover of another person's Personal Safety Lock.

The passing of Personal Safety Locks and/or keys from one person to another is strictly forbidden.

Personal Safety Locks must be removed when moving from one plant area to another, or at the end of a work period.

5.4 MULTI-CLASPS

Multi-clasps must be used each time that equipment is "locked-off". Five locks may be fitted to each multi-clasp, with the sixth hole being used for a subsequent multi-clasp. In this way, there is no limitation to the number of persons that can fit locks to an electrical isolator or mechanical isolation device.

Process: Safer by Sharing

Identifying Sources of Energy

Identifying energy sources will be a key part of the business risk assessment, which will determine the isolation procedures required for any machinery.

In order to isolate the equipment, time must be taken to identify the hazards present and the level of risk they pose. Energy comes in a variety of forms, all of which need to be isolated to prevent an incident from occurring. Once energy is released uncontrollably, it can easily escalate leading to a major accident.

- Moving Parts – e.g. Entrapment / Being struck
- Hydraulic / Pneumatic Pressure – e.g. Pressure release
- Electricity – e.g. Electrocutation / Inadvertent start up
- Flammable or Toxic Properties – e.g. Build-up of toxic and/or explosive gas
- Stored Energy – e.g. Springs under tension / Gravity (Falling objects)
- Engulfment – e.g. Engulfed by materials / Drowning
- Hazardous Environment – e.g. Depleted Oxygen / Bitumen

Once the energy sources have been identified it is important that each site asks the scale of risk that can be determined by considering:

- The nature and properties of the substance
- The quantity of energy/substance released
- The escalation potential (i.e. the presence of other plant, including confining structures, and other hazardous inventories)
- The populations at risk, their proximity to the plant and the speed with which they may be affected.

Questions every site should ask:

- Has a complete risk assessment been completed for each potential energy source?
- Does the risk assessment suggest suitable control measures for each potential energy source?
- Does the isolation training cover all the energy sources found on site?
- Is the isolation point considering all possible energy hazards?
- Who needs to be kept informed of the stored energy in their environments?
- How do you make the wider workforce aware of the energy sources present?
- Does the maintenance schedule consider areas of equipment that could store energy if faulty?
- If hazardous energy is released, how is it brought back under containment?

Best Practice Identifying Sources of Energy

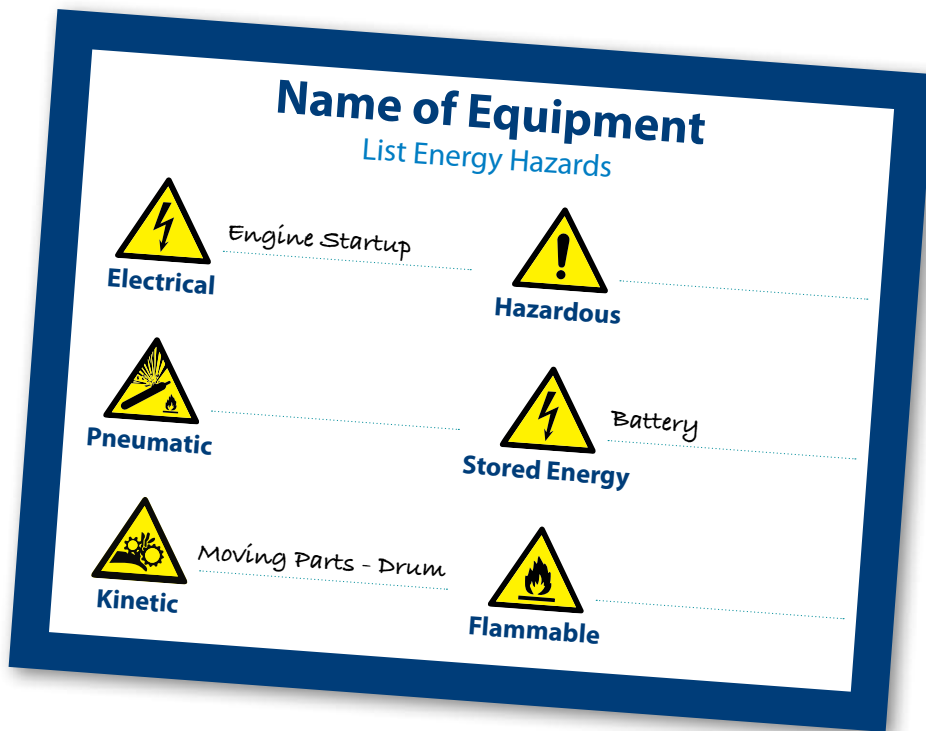

There are other pictograms and this is not an exhaustive list, others are available.



PLAN	DO	CHECK	ACT
Work to produce a HIRA that captures all potential energy sources on site	Ensure that all isolation processes consider the risk profile of each energy source	Follow a periodic structured audit to ensure an isolation process remains relevant, considering any changes that may have occurred since the energy source was first assessed	Identify areas where the HIRA needs updating or expanding upon to develop the next PLAN

Simple and Complex

Many businesses will include within their isolation documents a reference to “Simple” or “Complex” isolations once a certain threshold has been reached. For example, any more than three people might be classified as a “complex” isolation. However, these thresholds differ from company to company and even site to site. Whilst a person may be considered an Authorised Person to work on Complex Isolations in one area, they may not be in another. Furthermore, some isolations a company may categorise as “Simple” become “Complex” as the task progresses. For these reasons, the MPA chooses not to categorise certain isolations as simple or complex but expects the difficulty of the isolation to be reflected in the safety rules, which should embody a methodical approach in line with the risk profile of the isolation being carried out.

The complexity of an isolation can be increased by any of the following:

- Number of people working on the task or equipment
- Number of isolation points
- Number of identifiable forms of hazardous energy
- Any associated equipment identified
- Type of locks required to carry out a successful Lock-Out
- An increase in risk

If there is any uncertainty around whether or not an individual is authorised to work on an isolation, review the risk assessment with a Manager, Supervisor or Isolation Controller to advise how best to proceed. Once a decision has been made, ensure that the decision and the reasons behind it are communicated to the wider workforce.

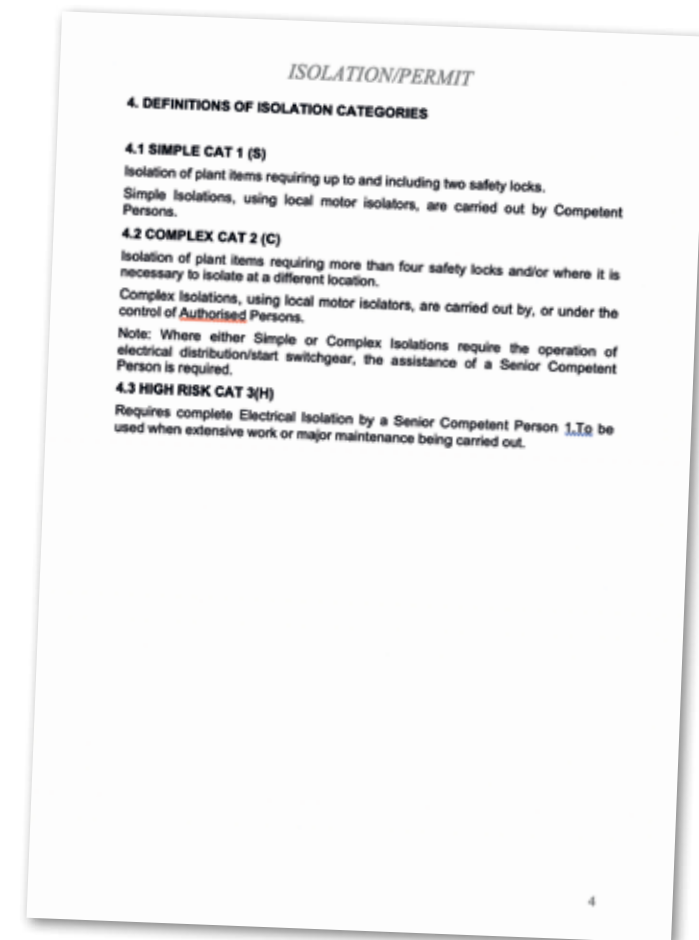

Written Isolation Procedures

Managers should establish a system of isolation policy standards to be used throughout the business. Site-specific procedures should then be produced by the site managers, referring to the company policy and standards. These procedures should be written in line with each site's isolation requirements. These should be decided as a part of the Isolation Action Plan and should be written down. This must then be communicated to everybody involved, as they will form the basis of task-specific risk assessments.

The amount of detail depends on the circumstances; the simplest form may be a brief policy statement (perhaps reflecting a policy of always switching off, securing the isolation, and never working on live equipment) backed up by a set of simple instructions to reflect that policy. Where there are extensive or complex electrical systems, especially high-voltage systems, this will be reflected in the safety rules, which should embody a methodical approach so that the safety principles involved can be clearly understood by everyone.

Safety rules should set out the principles and general practices clearly and in a compact format. Those carrying out the work should be instructed to carry the safety rules with them and it should be easy for them to do so. Workers should know the limitations of their work allowed under the safety rules, depending upon their level of competency.

Detailed procedures for safe working on certain equipment or under particular circumstances should be the subject of separate documents, including task-specific risk assessments or method statements, which should be readily available when required (even in out-of-hours emergencies). These safety rules should be devised to reflect, among other things, the relevant organisation, personnel, the electrical system to be worked on, and the working environment.

Questions every site should ask:

- How complex are my isolation needs?
- Will an isolation policy be enough to keep people safe if followed?
- Is the procedure available to everyone?
- Can the format of the procedure take advantage of visual or digital formats? E.g. Flow Chart Poster or App
- Are the procedures methodical and easy to follow?
- Are there any isolation tasks that require more specific risk assessments or method statements?
- How will the business organise these additional risk assessments or method statements so they are assessable to the people who need them?
- Can the isolation procedure be converted into a poster or Toolbox Talk to regularly remind people of its contents?
- In what ways can VFL be utilized to ensure the written procedure is meeting its aims?

Written Isolation Procedures

Here are some examples of site specific written procedures for isolation. Site specific procedures are not the same as company policies.

4.5 Isolation of energy sources

An isolation procedure is a set of predetermined steps that should be followed when workers are required to perform tasks such as maintenance, repair, installation and cleaning of plant.

Isolation procedures involve the isolation of all forms of potentially hazardous energy so that the plant does not move or start up accidentally. Isolation of plant also ensures that entry to a restricted area is controlled while the specific task is being carried out.

The lock-out process is the most effective isolation procedure. The process is as follows:

- shut down the machinery and equipment
- identify all energy sources and other hazards
- identify all isolation points
- isolate all energy sources
- control or de-energise all stored energy
- lock out all isolation points
- tag machinery controls, energy sources and other hazards, and
- test by 'trying' to reactivate the plant without exposing the tester or others to risk. Failure to reactivate the plant means that the isolation procedure is effective and that all stored energies have dissipated. This may require further measures to safely release these energies, for example hydraulic or pneumatic pressure, suspended weight or compressed springs.

EXAMPLE OF CORRECT ISOLATION

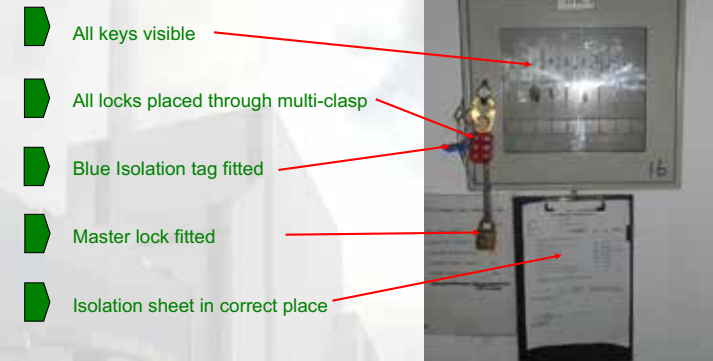

TO SUMMARISE



- ▶ **All** employees can carry out an isolation requiring 3 locks or less e.g. conveyor drive.
- ▶ **Don't** rely on someone else's isolation. All people working on a task must individually isolate with their own lock.
- ▶ **Always** check the database if you are unsure of isolation requirements.
- ▶ **Remember** the system is updated regularly and a current isolation is essential (date / time stamp).
- ▶ **All** isolations requiring more than 3 locks, involving more than 3 people and lasting more than one shift **must** be done by two authorised persons.
- ▶ **Point out anything** that you are unhappy with in respect of an isolation.
- ▶ **Use** kill switches, remove keys or immobilise vehicles / mobile plant.
- ▶ **ASK** if you're not sure.
- ▶ **Finally, use the system**, it's there for our benefit and it's a powerful tool to help us isolate plant in a safe and efficient way.

MAKE SURE YOU'RE SAFE ALWAYS ISOLATE

Energy Isolation / LOTOTO

HSE10 / Standard

The standard together with the associated documents aims to assist in the systematic approach to eliminate the risk arising from unexpected energisation, start-up or release of hazardous energy when performing tasks on machines, equipment or plant (MSEP). Specific focus will be on identifying energy sources & related risks and determining the control measures in site procedures necessary to prevent harm to people as well as damage or loss to MSEP and resources. Meeting the expectations of the standard will satisfy both Safety at Work etc Act 2015 and associated legislation.

Lack of appropriate isolation (LOTO) is the summary and preferred isolation method to control hazardous energy and to achieve zero energy state before carrying out the task. LOTOTO is required where the risk assessment for a task identifies a specific hazard which could result in a risk of injury from employment, contact with dangerous parts, crushing, an escape of solids, liquids or gases in a system, or potential for stored energy.

LOTOTO is required when individuals may be exposed to all forms of hazardous energy and/or hazardous substances/material such as:

- Electrical (live or charged);
- Gravitational;
- Pneumatic;
- Mechanically stored potential energy;
- Thermal and
- Chemical;
- Power in other solids;
- Radiation.

Site Survey of Energy Isolation and LOTOTO Requirements
A site survey shall be performed and documented to identify if the MSEP is capable of being effectively and securely isolated and LOTOTO as per the requirements of this standard, using the isolation survey form. A Guidance Note on Production Stops is available to determine the distinction between Production Stops and Energy Isolation/LOTOTO requirements.

For any new MSEP during the commissioning stage checks shall take place to ensure the MSEP meets the requirements of this standard, the survey shall be completed prior to being brought into service.

With any new business acquisitions, a survey shall be completed within 3 months of the date of the acquisition.

An **isolation guide** could be produced to support the sites energy isolation & LOTOTO procedure to locate the isolation devices and each isolation point shall be clearly labelled on the MSEP. See labelling example within the Guidance Note on **Labelling Methods**.

Energy Isolation and LOTOTO Procedure
All sites shall have documented site isolation procedure(s) which clearly define how the MSEP will be safely shutdown, isolated,

Scope
These requirements apply to all MSEP activities involving MSEP in the United Kingdom, Channel Islands and Gibraltar. Success in this document lies in the relevant law, but it is not intended to replace legislation.

These requirements shall be different to those that are defined in the sections below. This includes all work both on and off site activities on behalf of Appropriate Isolators which includes contractors.

Responsibility for implementing the procedure lies with the site management unless otherwise stated in some instances this may be assigned to a contractor, which is not intended to be interpreted as a substitute for the MSEP and a total audit shall be required to confirm the status of the management.

Site management are responsible for ensuring that suitable and sufficient energy isolation and LOTOTO procedures are in place to safely shutdown, isolate and



PLAN
Review the written procedures currently in place establishing that they are relevant to the needs of the isolation

DO
Communicate the written procedures to the operatives completing the isolations

CHECK
Ensure the operatives all have access to the procedures either on their person or permanently adjacent to the isolation points

ACT
Review and update the written procedures in line with the complexity of the task

Recording LOTOTO Events

An isolation register should include:

- Name of person applying personal lock
- Lock Number/s
- Isolation Matrix Unique ID or Complex Isolation Ref. No.
- Description of task being undertaken
- Equipment Isolated / Locked Out
- Signature of person completing Try-out
- Signature of person isolating and / or applying lock (Lock On)

Each should be maintained on site for a specified time after completion and then archived, to enable effective monitoring, audit and review of the isolation systems.

The MPA has collated examples of basic and advanced versions of each of these, which can all be accessed from the MPA website as a guide should your own business wish to use them as a template.

The image shows a form titled 'UKCP62.F3 LOTOTO Isolation Register' with the Hanson logo. The form is a table with the following columns: 'Number of permits to be isolated', 'Lock Number/s', 'Isolation Matrix Unique ID or Complex Isolation Ref. No.', 'Description of task being undertaken', 'Equipment Isolated / Locked Out', 'Signature of person completing Try-out', and 'Signature of person applying lock (Lock On)'. The table has multiple rows for recording data. At the bottom left, it says 'Version: UKCP62.F3' and at the bottom right, 'Page 1 of 2'.

Questions every site should ask:

- Is a register available?
- Are people using it?
- Are people signing off events?
- Are people trained and competent?
- Do you have your own personal locks and do they only have one key?
- Are there any duplicate keys in a cabinet or manager's office somewhere?
- Do you use tags to show who is working on equipment?
- Have you had a tool box talk on LOTOTO (Lock Out, Tag Out, Try Out) since the company changed its procedures on the 01.06.2010?
- How have you locked off the equipment you are working on and if so where?
- Can you show me the lock off point and is it convenient to lock out here?
- How do you try out for this piece of equipment?
- When is it necessary to have a Permit to Work on your site?
- Have you ever had to cut a lock off? If so, what is the correct procedure for this site?
- When was this electrical panel last inspected?
- Have you identified all the hazardous energies that might allow this equipment to move?
- Is there an isolation procedure for the task you are undertaking?
- If there is no isolation point for this equipment how do you prevent someone starting it?
- Do you need to have Arc Flash protection PPE?

Test Run

Test runs must be authorised by someone responsible on site.

Below is an example of a test running procedure. It is advisable that any test runs are signed off by Senior Management beforehand.

It may be necessary to de-isolate and run an item of plant before the full job is finished. If this is not covered by a Safe Working Procedure, the following procedure must be used:

1. All guards on the plant item to be test run must be securely replaced, or an Authorised Person must erect temporary guards where necessary and supervise each test run.

For a Simple Isolation as determined by the risk assessment:

2. Inform all persons working in or near the zone in which the plant item is to be test run and make sure they are clear.
3. Remove their Personal Safety Locks from the isolator of the plant item to be test run.
4. The plant item is then de-isolated and the test run carried out.
5. Before recommencing work, the plant item must be isolated again and the reinstatement of their personal padlocks.
6. If further test runs are required, repeat steps (2) to (6).

For a Complex Isolation:

7. Carry out step (1).
 8. Inform all persons working in or near the zone in which the plant is to be test run and make sure they are clear.
 9. Remove their Personal Safety Locks from the locking bar of the Complex Isolation Category Key Box.
 10. The Responsible Person removes the 'Engineering' lock, and takes out the 'A' Lock key for the plant item to be test run. He attaches a Test Run Tag to the item to be test run and to the 'Engineering' lock. He then refits the 'Engineering' lock to secure this Tag and the remaining 'A' Lock keys.
 11. The Responsible Person removes the 'A' lock from the plant item to be run, de-isolates it, and retains the 'A' Lock.
 12. The test run is carried out.
- Note: Individuals must not fit their Personal Safety Locks to any Complex Isolation Category Key Box displaying a Test Run Tag.**
13. When the test run is completed, the Responsible Person isolates the plant item again, using the 'A' Lock. He returns the 'A' Lock key to the Complex Isolation Category Key Box, securing it with the 'Engineering' Lock, and removes the Test Run Tags.
 14. Before recommencing work, Competent Persons must refit their Personal Safety Locks to the Complex Isolation Category Key Box.
 15. If further test runs are required, proceed in accordance with steps (7) to (14).

Shift Handover

Changing shifts is a requirement in any continuous process. While plants can operate 24/7, people need to take breaks. Shift handover should be regarded as a high-risk process because it cannot be automated and relies on human behaviour. The goal of the handover process is to maintain continuity and the formal transfer of responsibility and accountability between the respective parties.

Work that takes place across shifts

A shift roster is typically set up in advance to accommodate the need for people to work to a schedule. Shift changeover times are planned in advance. The reality of day to day operations is that certain tasks like critical repairs happen on their own time scale. These tasks, sometimes involving different teams can take place during two or more shifts. Other, bigger tasks such as a major repair on a cement kiln shutdown might take place over days, weeks or even months.

Shift handover procedure

To ensure continuity and minimise errors, a standard procedure is implemented for shift handover. It is recommended that each company develop their own procedure in line with their operational requirements. In practice we have observed that there is little standardisation of these handover procedures between member companies, and while some follow a very rigorous and defined process, others merely rely on individuals to communicate effectively.

Risks associated with shift handover

Considering that a typical shift is either 8 or 12 hours long, changeover happens 1095 or 730 times during the year; in other words there are 730 or 1095 high risk opportunities for miscommunication leading to safety incidents. Making sure that the changeover process itself is defined and managed properly is a priority area to focus on when looking for ways to improve safety on the plant.

Several studies into shift handovers have been done to better understand ways to improve the procedures. One such HSE study analysed a number of incidents involving planned maintenance work and found that the following shift handover-related risks were contributing factors to accidents and fatalities:

- In some of the incidents, planned maintenance work continued over a shift change.
- Thorough [coordination and] communication of such work should be afforded a very high priority.
- Operator support [logs] were not designed to capture key information reliably and unambiguously.
- A lack of procedures that specified how to conduct an effective shift handover was evident.
- Inaccurate and unreliable carry-forward of written information from shift to shift was evident. For example, reference to a temporary safety system override was not carried forward.

The permit to work and shift handover

In typical industrial environments the permit to work makes sure that communication takes place between all people involved in dangerous, non-routine tasks on the plant.

So, what should happen to these permits at shift handover?

Two approaches are possible:

- The permit is closed off and a new permit issued by the incoming shift or team for the work to continue.
- A shift handover procedure is implemented that ensures that responsibility is transferred from the outgoing to the incoming persons on the permit document itself.

The first approach takes more time but forces a fresh review of the job and helps ensure that communication takes place.

The second approach is more streamlined but runs the risk that something important changes that is not adequately interrogated by the responsible persons at changeover. On handover there should always remain a controlled lock that maintains the integrity of the isolation during the handover period and only removal of personal padlocks takes place. The person(s) authorised to remove the final controlled lock when cancelling the permit should be defined in the company Isolation Policy/Standards along with the agreed level of competence required of those individuals.

In practice there is often confusion as to which of the two approaches is best within a single company, and the procedures also differ not just between members but also industries. Unsurprisingly for example, in the nuclear industry a much more structured handover process is followed than other industries such as in chemicals manufacturing.

The HSE study [1] also found an interesting disconnect. In a survey of chemical plant personnel, the majority of fitters and supervisors were of the view that a new permit should be issued at changeover, while the majority of managers believed that the work should carry on using the same permit. This lack of alignment should be of concern as it seems as there is scope for confusion and human error. HSG 250 Guidance on Permit to Work Schemes.



CRH Tarmac Cement and Lime
Safety Procedure



3: Energy Isolation

ENERGY ISOLATION HANDOVER CERTIFICATE-SIMPLE ISOLATION

HECP No: _____ Cert No. _____ Prior Cert. No: _____ Handover Lockbox No: _____

Section 1 - Details of Machinery, Equipment, Process (MEP) to be Isolated, Immobilised and Handed Over			
Description/Location of the MEP Isolator	Drive/Handover Lock No	Authorised Individual Print Name	Authorised Individual Signature

Section 2- DESCRIPTION OF WORK AND REASON FOR HANDOVER – Completed By The Authorised Individual

INSERT LOCATION: _____

Section 3- CONFIRMATION OF ISOLATION – Completed By Authorised Individual (AI)

I confirm that the Handover Sequence for energy isolation has been applied to all the MEP Isolators detailed in Section 1, the handover locks are placed in the handover lock box and an RP lock has been applied.

INSERT LOCATION: _____

RP Print Name: _____ Signature: _____ Date: _____ Time: _____

Section 4- CANCELLATION OF HANDOVER - Must Be Completed By An AI

I confirm that the Handover Locks above have been removed a new Simple Isolation applied by following the Mandatory Sequence 1 to 8 for energy isolation has been applied to all the MEP Isolators detailed in Section 1 and that it is safe for work to begin

Note Handover locks must be returned to the handover isolation lock box once AI locks have been applied and mandatory sequence 1-8 completed

AI Print Name: _____ Signature: _____ Date: _____ Time: _____

Padlock Removal Authorisation

Any event where a padlock is needed to be removed by force is considered a failure in the Isolation Process and needs to be thoroughly investigated. All responsible persons should know not to leave a lock on before leaving the building, but such a lock may need to be removed before production can restart. Good training, communication and resources should prevent this from ever occurring and a return to the Action Plan may be required in order to resolve the root cause that led to the padlock removal in the first place. The process to remove your padlock must be documented in the corporate procedure. However, in this event strict procedure must be followed:

1. Verify that the authorised person is not on site. In order to prevent a padlock from being forcibly removed, all attempts should be made to return the employee to site to remove their own padlock.
2. Make all reasonable efforts to contact the employee. This should be through direct contact or communication. This is to ensure they are safe before isolation is removed. Communication from a friend or partner of the employee would not be direct contact.
3. Complete a full search of the work environment to ensure that no-one else is in the the danger zone and is clear for the isolation to be removed.
4. Gain authorisation to remove the padlock
5. Confirm or inform the employee that the lock was removed on his or her return to work.
6. Fully investigate the incident as an incident and not as a near miss.

The form is titled "Forced Removal of Padlock Authorisation". It contains a table with columns for "Date of Incident", "Location of Incident", "Description of Incident", "Authorised Person", "Date of Removal", and "Date of Return". Below the table, there are sections for "Approved by Name", "Approved by Signature", "Approved by Date", and "Authorising Manager". At the bottom, it states "All forced removals require authorisation and should be reported via the company internal system (MIS) to the Manager and retain a copy of this completed document here." and "Page 1 of 1".

Questions every site should ask:

- Does your site have shifts or personnel change which will require a handover process?
- Are all Authorised Persons trained on the correct handover process?
- Is the handover process thorough enough to ensure that full isolation procedure isn't required in the event of a successful handover?
- Does the handover process have supervisor involvement?
- In the event that a handover is not successful, do you have a padlock removal process in place?
- Does the process of removing padlocks go through the correct chain of command?
- What is the investigation process for when a padlock needs to be removed?



PLAN
Assess the instances where a handover process may be required within the business

DO
Train and follow either a direct or supervisor controlled handover based on the isolation needs of the business

CHECK
Refer to the handover procedure forms to confirm correct handover processes are being utilised. Check incidents for padlock removal

ACT
Develop your next PLAN based on the compliance of your procedure in the CHECK stage

LOTOTO

The industry operates equipment that has the potential to cause harm if not operated or isolated correctly. We have seen from incidents within the industry that giving employees and contractors as much information and guidance on the risks involved when operating heavy machinery and the types of energy to be protected against is critical.

The term “Lock-Out, Tag-Out, Try-Out” (LOTOTO) refers to a safety procedure that ensures that dangerous machines and energy sources are properly shut off and cannot unexpectedly start up before the completion of maintenance or servicing work. These energy sources could include electrical, mechanical, hydraulic, pneumatic, chemical, radiation, and thermal hazards.

LOTOTO focuses on testing controls before completing any tasks and equipment. This simple addition to the process would identify if there are any faults with the Isolation Point(s), and if there are, any work wouldn't be carried out until the investigation into the fault has been diagnosed and safe to continue.

The point of a LOTOTO procedure is to identify a hazard that may injure or even kill people if such an incident occurs due to the start-up or release of stored energy during the maintenance and testing of machines and equipment. Lock-Out, Tag-Out and Try-Out procedures ensure that the hazardous power sources are isolated and rendered inoperative before any maintenance work is started. A lock is used that prevents the power source from being switched on. A tag affixed to the locked device cautions that it should not be turned on. LOTOTO describes a safe work procedure and identifies tasks and equipment that may expose employees to hazardous energy.

Questions every site should ask:

- Is the right person carrying out isolations for the business? This should take into account their competency as well as their role and responsibilities.
- Does the business provide personal locks with a single, unique key?
- Are there any duplicate keys in a cabinet or manager's office somewhere?
- Does the business use tags to show who is working on equipment?
- Is the correct level of training provided for the isolation needs of the business?
- What resources are in place to support the training e.g. Toolbox Talks, Safety Briefings etc?
- Are clear lock off points identified on every plant or piece of equipment?
- Is there a safe way to “Try-Out” all equipment and plant?
- Is it clear when it is necessary to have a Permit to Work on your site?
- What is the correct procedure for cutting a lock off?
- How often is the electrical panel inspected and is this done in house or by external inspectors?
- How are all hazardous energies that might allow equipment to move identified to employees?
- If there is no isolation point for this equipment what measures can be put in place to prevent someone starting it?
- Does the business provide Arc Flash protection PPE?

Best Practice LOTOTO

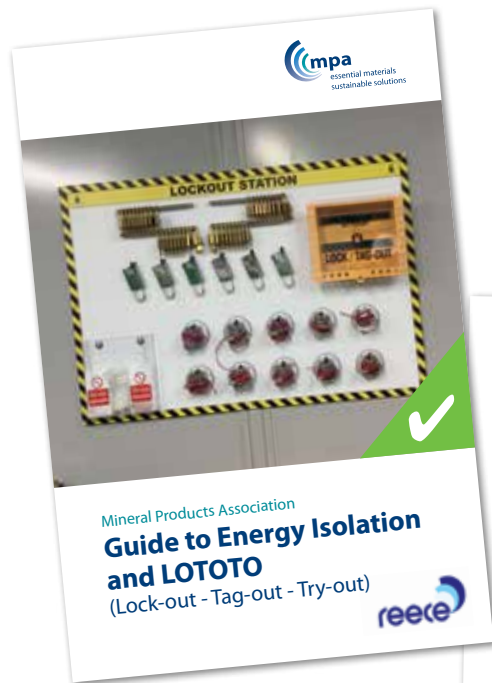

LOTOTO 9 Steps



LOTOTO Step 1 - Prepare

Responsible individual in charge:

- Reviews the Work Order.
- Performs a pre-job briefing if required.
- Reviews the machinery, equipment and process together with any associated Risk Assessment and Safe Working Practice.
- Completes associated paperwork or a permit/schedule of isolation for the work.

LOTOTO Step 2 - Notify

Responsible individual notifies ALL affected individuals:

- Via control room, radio, physical entry to the area or other appropriate method.
- Notifies people that the equipment will be isolated.
- Advises them to stay clear.
- Instructs them not to operate the equipment or process.

LOTOTO Step 3 - Turn Off / Shutdown

The responsible individual for LOTOTO:

- Turns off, shuts-down and de-energizes the equipment by referring to the specific procedure.
- The machine or equipment shall be shut down in an orderly manner to avoid additional hazards due to stoppage.

LOTOTO Step 4 - Isolation

All Personnel:

- Where safe to do so, starting and running the equipment prior to isolation identifies if the machine has other electrical defects which could compromise the isolation process.
- The machine or equipment shall be isolated by using its energy-isolating devices and not its operating controls.
- Don't use the STOP button or EMERGENCY STOP for isolation.
- Physical barriers are to be equipped with a locking device.
- Consider and isolate all other sources of energy e.g. hydraulic and pneumatic.
- If panels have a window where physical disconnect can be viewed, confirm the contactors have parted.



LOTOTO Step 5 - Apply Locks

One Lock, One Person, One Energy Source:

- Locks should be applied to each energy isolation device.
- A personal lock plus a tag to be fitted to each isolation point.
- Additional persons on the same equipment must apply their own lock and tag.
- Check isolation cannot be defeated (multi-hasp, lock boxes and padlocks secure).

If any energy source is unable to be locked out, an alternative method and information tag must be applied as a means of protection.

Plus further measures:

- Pull fuses (lock them in a lock box for instance) or take air pipes off
- Blocking or controlling of a switch
- Bleeding lines, valves and tanks
- Securing valve handles
- Locking rooms
- Other effective means
- Action plan raised to address issue
- Procedures for locking out and applying tags to non standard equipment must always be assessed and discussed with a supervisor/manager
- Ensure distribution board is locked
- Tag removed only by responsible authorised person
- Tag never bypassed, ignored or defeated.

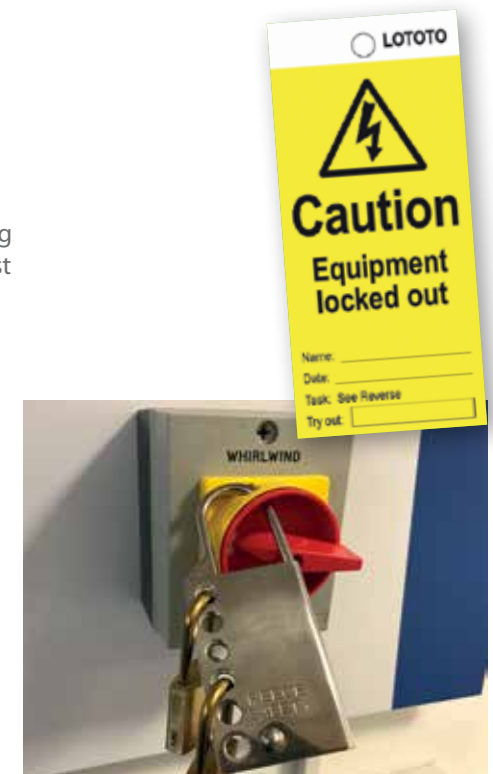

LOTOTO Step 6 - Zero Energy State

- Is where all hazardous energy has been released, and rendered safe.
- Where stored energy still presents a hazard, additional procedures shall be developed to dissipate it or restrain it (e.g. chains).
- Make sure they work (Try Out).
- Ensure energy can not re-accumulate (e.g. air systems).
- Remember: conveyors for instance roll back if no backstop is fitted.

Typical Types of Energy

Electrical Drive Motor (not shown)
Pneumatic (not shown)

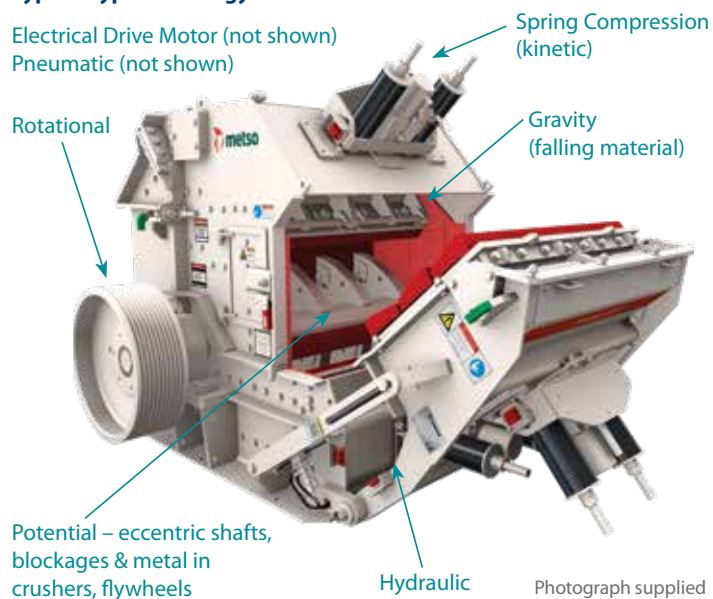

Photograph supplied
courtesy of Metso

LOTOTO Step 7 - Try-Out

Attempt to operate the equipment by its normal operating controls (either from the control room or from the local start), to ensure the correct equipment or process:

- Has been de-energized
- Will not operate

Where equipment can be started from more than one source, try the start process with site electrical support if in any doubt.

Pay particular attention to, and care with, automated equipment operated via sensors, timers, etc. which may start unexpectedly e.g. packers, palletisers.

If the equipment or process operates:

- Task should be stopped
- Equipment shall be shut down
- Supervisor shall be notified
- Near Hit/Miss raised
- Investigation to be completed

ALWAYS TEST BEFORE YOU TOUCH

Prove the integrity and effectiveness of isolations before beginning work. All isolations must be secured, monitored and maintained throughout the work task.



LOTOTO Step 8 - Perform Task

Complete the task as per the risk assessment and safe working practice requirements.

If at any point it is suspected that stored or other energy has not been isolated or rendered safe, immediately:

- Stop the task
- Withdraw all personnel
- Implement control measures
- Report near miss/hit
- Investigate



LOTOTO Step 9 - Inspect and Restore

Responsible individual to:

- Visually inspect the area
- Ensure guarding is in place and secure
- Notify all affected individuals that power will be restored and ensure everyone is clear of the equipment
- Remove all lock-out devices and tags. Never remove another individual's personal locks or tags
- Restore all devices to the operating position and verify everything is operating properly
- Notify the supervisor or production that the equipment or process is back in service
- Complete associated paperwork including Isolation Registers, and permits where required
- Have a procedure for test running if required
- Transfer ownership back to production
- Refix locks if it doesn't restart



PLAN	DO	CHECK	ACT
Identify sources of hazardous energy and confirm they can be isolated during maintenance	Ensure everyone authorized to LOTOTO is fully trained and issues with a personal, single key padlock	Review near miss/hit and hazard observations to highlight any non-compliance of LOTOTO procedure	Build upon your initial PDCA Cycle to extend awareness in the form of a Toolbox Talk

Performance: Safer by Association



HSE Statistics
2017/2018

Audit

Safety audits are an essential part of a successful business. Effective health and safety auditing not only provides the legal framework for compliance, it also lays the foundations for continuous safety improvement to enhance competitive advantage. The main duty of any health and safety auditor is to look at your organisation's safety management systems and assess them in line with the chosen criteria. Whilst an audit is used to assess health and safety management systems, it is important to view an audit as a positive; it's a chance to highlight company successes and an opportunity to praise staff for their excellent work.

There is no right or wrong time to conduct an audit. They can be useful tools whether you are starting out in the PLAN stage of the PDCA cycle, or if you are reviewing your performance and looking to ACT upon the results.

In order to develop your PLAN, you need to understand your gaps. This tool will identify your gaps that enable that PLAN.

As a part of the PDCA cycle remember to include the way audits are carried out and that they capture all the needs of your business.

QNJAC and other audits are available from QNJAC and Safequarry Websites.

SITE ISOLATION PROCEDURES – SELF AUDIT



Location: _____ Carried Out By: _____

Date: _____

	QUESTION	YES	NO	N/A	COMMENTS / ACTION	Who / When
FACILITIES & EQUIPMENT	1. Are all moving parts of machinery suitably guarded in accordance with the MPA Safe Guarding Guidance?					
	2. Is the operation of switches, valves and machinery clearly labelled?					
	3. Has it been confirmed with a suitably qualified person that electrical isolation systems cut off the energy supply, rather than control circuitry?					
	4. Is it possible to lock out all forms of stored energy when isolating equipment?					
	5. Is an isolation station in place, with suitable equipment and individual padlocks that are labelled with a unique name or number?					
	6. Are hasps available, allowing multiple padlocks to be applied, and are they used where several people are working on the same machinery?					
	7. Are individual padlocks with unique keys used by each person to lock off, and are the keys retained by each individual doing the work?					
	8. Are isolation tags / warning signs displayed at each isolation point when locked off?					
	9. Where captive key isolation systems are used, do they ensure the electrical supply remains isolated?					
	10. Do captive key systems isolate all equipment leading to / from the machinery to be worked on?					
	11. Do captive key systems also release and make safe all sources of stored energy or, where this is not possible, are separate documented isolation systems in place?					
	12. Do captive key isolation systems ensure it is not possible to re-energise the plant until all the individual access keys have been returned and any individual padlocks removed?					
	13. Are master keys and duplicate keys for padlocks, trap key systems, etc. prohibited?					
	14. Have checks been made to ensure isolators cannot be locked in the "on" condition?					
PROCESSES	15. Risk assessments and isolation procedures: <ul style="list-style-type: none"> Do they ensure machinery cannot be operated while people are exposed to danger? Are they specific and sufficiently detailed for the different equipment that may need to be isolated? Do they take account of all isolation tasks i.e. preparation work (releasing stored energy etc), removal of guarding, monitoring, testing and reinstatement of machinery? Do they consider the isolation requirements for all sources of energy e.g. electrical, gravitational, hydraulic, pneumatic, chemical, heat, etc? Do they consider machinery that may operate automatically due to sensors or timers? 					
	16. Do the risk assessments and procedures consider all potential maintenance tasks?					

	17. Are risk assessments and procedures reviewed whenever there is a change in activity that hasn't been considered previously and at least annually?					
	18. Do guarding and isolation systems ensure it is not possible to enter a live area from an isolated area?					
	19. Do the procedures follow the following strict hierarchy wherever practicable*: A. All electrical equipment locked out at one location via the main power source B. Zonal isolation C. Local isolation, interlinked so that in addition to the equipment being worked on, equipment upstream and downstream is also isolated. * - For compact sites, such as concrete plants, the general aim should be to isolate all the equipment from the main power source at one point; however for larger sites, zonal / local isolation may be necessary to ensure people are not deterred from locking out equipment due to the time / trouble reaching the isolation station.					
	20. Are the risk assessments and procedures well communicated / understood and are they readily available, being displayed at / close to the point of work?					
	21. For more complex isolation systems are isolation cards, colour coding, etc. used to help ensure all the correct equipment is isolated? (Please share good practice with the H&S team)					
	22. Before guards are removed, do the procedures include the requirement to attempt a "test start" to confirm isolation is effective?					
	23. Where contractors are required to isolate machinery, does the Permit to Work specify / reference the requirements in sufficient detail?					
	24. Where practicable, do procedures include the requirement for a "Manager in Charge" lock, where the manager / supervisor in charge also locks out, helping ensure equipment cannot be reenergised unless returned to a safe state?					
	25. Where the isolation has to be applied for more than one shift, are there handover procedures in place to ensure the isolation remains effective with everyone locked out?					
	26. Do captive key isolation procedures prevent entry to danger areas without a safety key or the application of personal lockout?					
	27. Is there a formal check to ensure equipment has been returned to a safe condition before the isolation is removed?					
PEOPLE	28. Have all employees who are required to isolate machinery been trained in Lock Out, Tag Out, Try Out, is their understanding of the procedures assessed and are they formally authorised*? * - Authorisation should be via a documented approved list / register.					
	29. Is refresher training in LOTOTO repeated annually and does it include a practical assessment of site specific requirements?					
	30. Have all persons who supervise work on machinery been trained in the relevant isolation procedures?					
	31. Do supervisors carry out regular checks to ensure isolation procedures are being followed?					

ALL "NO" RESPONSES SHOULD BE ASSIGNED AN IMPROVEMENT ACTION...WHERE THIS IS NOT FELT POSSIBLE, THE ISSUE SHOULD BE ESCALATED TO THE LINE MANAGER AND H&S SPECIALIST



Reporting of Incidents/ Near Miss/Investigations

Accident Investigation and near miss/hit reporting monitors the effectiveness of the PDCA PLAN the business has put into place to control the risks. As part of the CHECK section of the PDCA cycle, all incidents should be investigated to best inform the corrective action. Once this action is decided upon it is essential that it is implemented, learning is shared, and any necessary improvements are put in place.

Investigations will help a business to:

- identify why any existing control measures failed and what improvements or additional measures are needed
- assist in preventing the incident from happening again
- point to areas where the documentation needs reviewing
- improve risk control in the workplace in the future

An incident need not occur for an investigation to take place as valuable information can be retrieved through near miss/hit and hazard observations of unsafe acts and unsafe behaviours. Looking into these instead of waiting for an accident to occur can be invaluable in preventing the accident from ever happening.

Incident – this is an event that causes injury to a person of any degree of seriousness, or damage to property and equipment, e.g. a driver climbs into the back of his mixer to clean it out without taking the key from the cab. A second individual starts the vehicle without knowing the driver was in the drum.

Near Miss – this is an event that occurs without injury or damage to property e.g. the skip support on a dumper not being correctly placed resulting in the skip's coming down uncontrolled.

Unsafe Act – in which the behaviour of a group or individuals increase the risk of an incident occurring e.g. operatives trying to remove debris from a conveyor without isolating the machine.

Unsafe Condition – in which the working conditions such as environment or equipment increased the risk of an accident occurring e.g. guarding on a conveyor missing bolts or with badly damaged/rusted bolts. Good safety conversations as discussed in the Leadership pages of this document, can highlight both unsafe acts and unsafe conditions.

Analysis and further action

18 What were the immediate, underlying and root causes?

Analysis (see 'Analysis' under 'Step two')

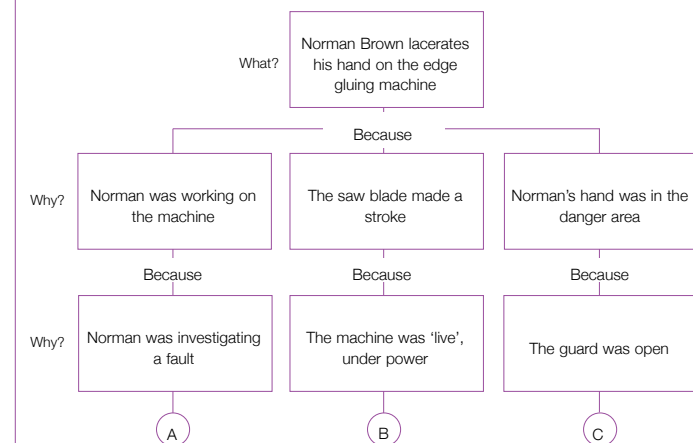

Analysis and further action

18 What were the immediate, underlying and root causes?

Analysis (see 'Analysis' under 'Step two')

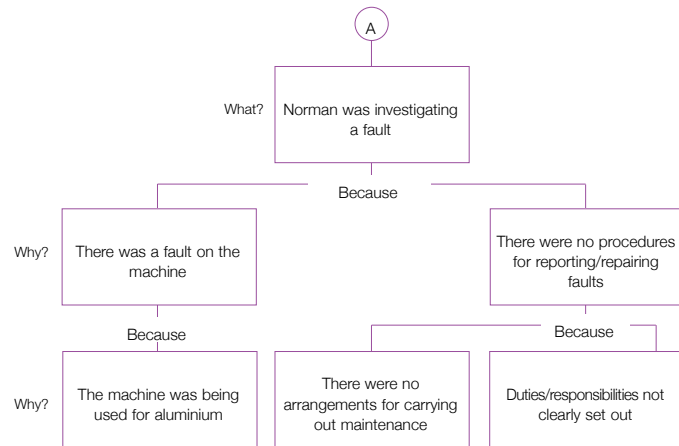

Analysis and further action

18 What were the immediate, underlying and root causes?

Analysis (see 'Analysis' under 'Step two')

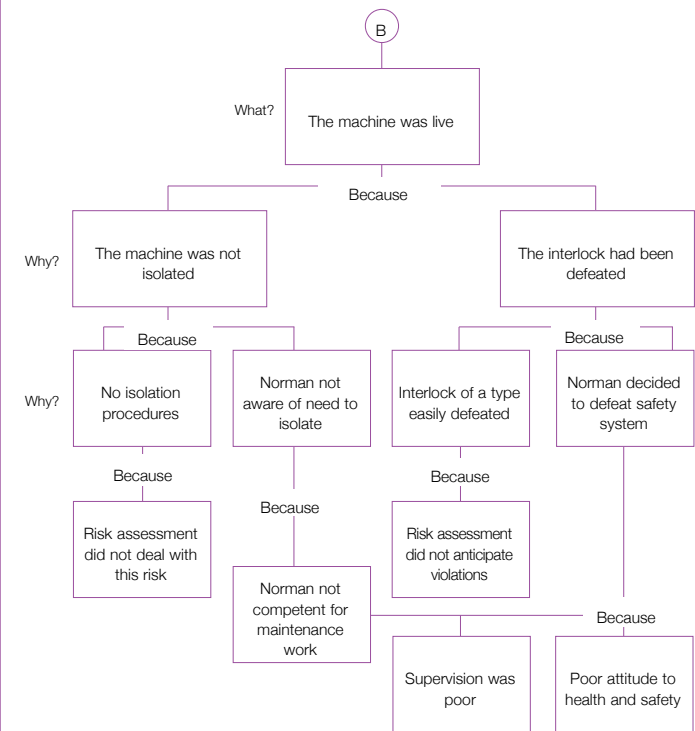

Analysis and further action

18 What were the immediate, underlying and root causes?

Analysis (see 'Analysis' under 'Step two')

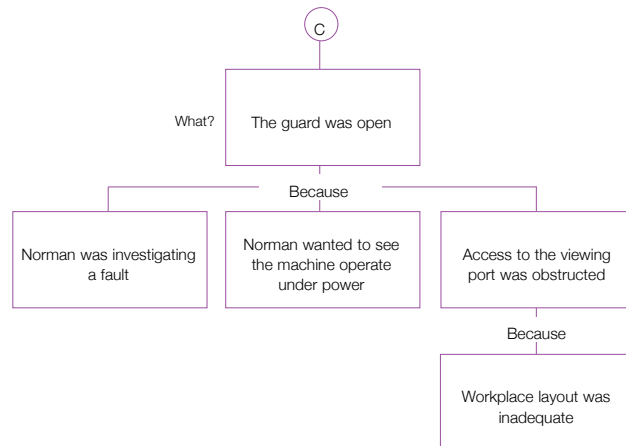

Questions every site should ask:

- Is everyone in the business equipped with the means to report hazards, near misses/hits or incidents?
- Who in the business is trained and responsible for incident investigations?
- Who in the business is trained to complete risk assessments?
- Do all employees understand how to read a risk assessment and what actions they need to take?
- Is the risk assessment assessed as a part of the incident investigation?
- Does the incident investigation take into account environmental effects?
- Does the incident investigation take into account the quality of the product?
- Does the incident investigation utilise the '5 whys' approach to establish the root cause of incidents?
- How does the business share the learnings and best practice from an incident investigation within the organisation?
- How does the business share the learnings and best practice from an incident investigation in the wider industry?

Leading/Lagging Indicators

Indicators are any metrics that a business produces that can be used to inform a PLAN in the PDCA cycle. Indicators are commonly separated into two types, Leading and Lagging, although the goal of measuring both is to assess safety performance and determine what needs to be done to improve the safety culture of an organization.

Lagging indicators are reactive in nature. They can only record what has already happened. They measure the effectiveness of a safety program after a PLAN has been implemented.

Typical lagging indicators include:

- Number of Fatalities
- Number of Lost Time Incidents
- First Aid or Minor Injuries that didn't result in Lost Time
- Damage to Equipment/Property
- Equipment Failure or Breakdown
- Near Misses/Hits
- Unsafe Acts, Unsafe Conditions Reported

Businesses of all sizes measure lagging indicators because they are easy to record and quantify.

In contrast, leading indicators are proactive in nature. They predict what the performance outcome will be. They consist of safety initiatives or reported activities, with the aim of preventing adverse events before they happen. In stark contrast to lagging indicators, which will never change, leading indicators grow and develop in line with a business's maturity. As a company progresses, getting nearer to targets of 'zero harm', lagging indicators tell us less and less whereas leading indicators help a business to continue to develop in a positive way.

How to Set Indicators

Good HSE indicators, whether they are leading or lagging, should be reliable, repeatable, consistent and independent.

To be of use in improving safety and health, leading and lagging indicators should:

- allow accurate and detailed comparisons
- lead to correct or help avoid erroneous conclusions
- be well understood by everyone, especially those responsible for implementing change
- have a quantitative basis (even when measuring a qualitative dimension)
- measure what they are supposed to, consistently, accurately and reliably
- collect information that is relevant to the required management decisions and actions
- adequately map and identify causal linkages (root causes, precursors, events and outcomes)
- prompt an appropriate response leading to consistent focus on implementing change

Leading Indicators	Lagging Indicators
are actionable, predictive and relevant to objectives	are retrospective
identify hazards before the fact	identify hazards after the fact
allow preventative actions before the hazard manifests as an incident	require corrective actions to prevent another similar incident
allow response to changing circumstances through implementing control measures before the incident	indicate that circumstances have changed; control measures can be implemented after the incident
measure effectiveness of control systems	measure failures of control systems
measure inputs and conditions	measure outcomes
direct towards an outcome that we want or away from an outcome that we don't want	measure the current outcome without influencing it that we don't want
give indications of systems conditions	measure system failures
measure what might go wrong and why	measure what has gone wrong
provide proactive monitoring of desired state	provide reactive monitoring of undesired effects
are useful for internal tracking of performance	are useful for external benchmarking
identify weaknesses through risk control system	identify weaknesses through incidents
are challenging to identify and measure	are easy to identify and measure
evolve as organizational needs change	are static

Remembering the ideas of Visible Felt Leadership that are explored at the beginning of this guide, leading indicators are driven by an increased awareness of organizational and human factors when it comes to incidents. To be successful, leading indicators need to be a part of an overall business approach.

Leading indicators that are set too ambitiously, before a business has reached an appropriate maturity level to implement them, will find they cannot be met, and efforts are wasted.

Examples Of OHS Leading Indicators Linked To Maturity Levels

Leading Indicator Level	OHS Leading Indicator	Metric
3: Learning*	Agreed responsibilities and accountabilities from "Responsible Persons" authorised to isolate	% staff
	Risk assess contact with moving machinery and Isolations	%
	Delivery a discussion based Toolbox Talk on Isolation	%
	Perception of a caring organisation	Consistency across levels
	Effectiveness of isolation briefings/training	Observation/questionnaire
	Improvements in contact with moving machinery and isolation shared between sites	Number
	Effectiveness of Visible Felt Leadership	Various
2: Improvement	Feedback on positive and negative issues regarding guarding maintenance across sites	Reported at and by all levels
	Health and safety policy to include contact with moving machinery and isolation	Adequately communicated
	Management commitment to leading indicators	Staff perception
	Leading indicator objectives set and achieved	Extent
	Planned risk assessments vs completed	%
	Isolation briefings	Frequency
1: Compliance	Close-out of audit recommendations from an isolation audit such as QNJAC	% on time
	Behaviour-based task observations	% against
	Health and safety policy	Published
	Legislation addressed by procedures	%
	Management system compliant with recognized system	%
	Statutory training requirements for all responsible persons	% complete
	Behaviour-based task observations	Number
OHS included in communication	Frequency	

Indicators of both types need to be used in conjunction with one another to most effectively improve overall safety. A lead indicator without a lag indicator will increase the proactivity of a business but it will not provide confirmation that a business result has been achieved.

Reference

MINERAL PRODUCTS ASSOCIATION (MPA)

MINERAL PRODUCTS QUALIFICATION COUNCIL

QUARRIES NATIONAL JOINT ADVISORY COMMITTEE (QNJAC)

Website Links

Mineral Products Association
www.mineralproducts.org

Mineral Products Association Safequarry Web Site
www.safequarry.com

MP skills
www.mpskills.co.uk

Proctor Machine Safety
www.machinesafety.co.uk

DJB Machinery Compliance
machinerysafetycompliance.com

Rema Tip Top
www.rema-tiptop.com

Reece Safety
www.reecesafety.co.uk

BSI
www.bsigroup.com/en-GB/

Appendix

Machinery safety standards

This page lists the main machinery safety standards. Although British Standard references are used (eg BS EN ISO 12100), 'EN' signifies a European standard and, where appropriate, 'ISO' indicates that the standard is international as well. All machine guards designed and manufactured or assembled by Procter Machine Safety comply with relevant standards. For customers outside the European Union, we can design and manufacture guards that comply with other national standards as appropriate.

A-type standard

A-type standard: this specifies basic concepts, terminology and design principles applicable to all categories of machinery.

Safety Standard	Description
BS EN ISO 12100:2010 Safety of machinery.	General principles for design. Risk assessment and risk reduction

B-type standards

B-type standards deal with specific aspects of machinery safety or specific types of safeguard that can be used across a wide range of categories of machinery (NB this list is not exhaustive).

Safety Standard	Description
BS EN 349:1993 +A1:2008 Safety of machinery	Minimum gaps to avoid crushing of parts of the human body
BS EN 547-1:1996 +A1:2008 Safety of machinery.	Human body measurements. Principles for determining the dimensions required for openings for whole body access into machinery
BS EN 547-2:1996 +A1:2008 Safety of machinery.	Human body measurements Principles for determining the dimensions required for access openings
BS EN ISO 13849-1:2015 Safety of machinery.	Safety-related parts of control systems. General principles of design

Safety Standard	Description
BS EN ISO 13849-2:2012 Safety of machinery.	Safety-related parts of control systems. Validation
BS EN ISO 14120:2015 Safety of machinery.	Guards. General requirements for the design and construction of fixed and movable guards
BS EN ISO 14122-1:2016 Safety of machinery.	Permanent means of access to machinery. Choice of fixed means and general requirements of access
BS EN ISO 14122-2:2016 Safety of machinery.	Permanent means of access to machinery. Working platforms and walkways
BS EN ISO 14122-3:2016 Safety of machinery.	Permanent means of access to machinery. Stairs, stepladders and guard-rails
BS EN ISO 14122-4:2016 Safety of machinery.	Permanent means of access to machinery. Fixed ladders
BS EN 547-3:1996+A1:2008 Safety of machinery.	Human body measurements. Anthropometric data
BS EN 574:1996+A1:2008 Safety of machinery.	Two-hand control devices. Functional aspects. Principles for design
BS EN 614-1:2006+A1:2009 Safety of machinery.	Ergonomic design principles. Terminology and general principles
BS EN 614-2:2000+A1:2008 Safety of machinery.	Ergonomic design principles. Interactions between the design of machinery and work tasks
BS EN 842:1996+A1:2008 Safety of machinery.	Visual danger signals. General requirements, design and testing
BS EN 894-1:1997 +A1:2008 Safety of machinery.	Ergonomics requirements for the design of displays and control actuators. General principles for human interactions with displays and control actuators
BS EN 894-2:1997 +A1:2008 Safety of machinery.	Ergonomics requirements for the design of displays and control actuators. Displays
BS EN 894-3:2000 +A1:2008 Safety of machinery.	Ergonomics requirements for the design of displays and control actuators. Control actuators
BS EN 894-4:2010 Safety of machinery.	Ergonomics requirements for design of displays and control actuators. Location and arrangement of displays and control actuators
BS EN 981:1996 +A1:2008 Safety of machinery.	System of auditory and visual danger and information signals
BS EN 1005-1:2001 +A1:2008 Safety of machinery.	Human physical performance. Terms and definitions

Safety Standard	Description
BS EN 1005-2:2003 +A1:2008 Safety of machinery.	Human physical performance. Manual handling of machinery and component parts of machinery
BS EN 1005-3:2002 +A1:2008 Safety of machinery.	Human physical performance. Recommended force limits for machinery operation
BS EN 1005-4:2005 +A1:2008 Safety of machinery.	Human physical performance. Evaluation of working postures and movements in relation of machinery
BS EN 1672-2:2005 +A1:2009 Food processing machinery.	Basic concepts. Hygiene requirements
BS EN 1837:1999 +A1:2009 Safety of machinery.	Integral lighting of machines
BS EN ISO 3744:2010 Acoustics.	Determination of sound power levels and sound energy levels of noise sources using sound pressure. Engineering methods for an essentially free field over a reflecting plane
BS EN ISO 4413:2010 Hydraulic fluid power.	General rules and safety requirements for systems and their components
BS EN ISO 4414:2010 Pneumatic fluid power.	General rules and safety requirements for systems and their components
BS EN ISO 4871:2009 Acoustic.	Declaration and verification of noise emission values of machinery and equipment
BS EN ISO 7010:2012 +A7:2017 Graphical symbols.	Safety colours and safety signs. Registered safety signs
BS EN ISO 7731:2008 Ergonomics.	Danger signals for public and work areas. Auditory danger signals
BS EN ISO 9614-1:2009 Acoustic.	Determination of sound power levels of noise sources using sound intensity. Measurement at discrete points
BS EN ISO 9614-3:2009 Acoustic.	Determination of sound power levels of noise sources using sound intensity. Precision method for measurement by scanning
BS EN ISO 1161:2007/A1:2010 Safety of machinery.	Integrated manufacturing systems. Basic requirements
BS EN ISO 11200:2014 Acoustics.	Noise emitted by machinery and equipment. Guidelines for the use of basic standards for the determination of emission sound pressure levels at a workstation and at other specified position

Safety Standard	Description
BS EN ISO 11201:2010 Acoustics.	Noise emitted by machinery and equipment. Determination of emission sound pressure levels at a workstation and at other specified positions in an essentially free field over a reflecting plane with negligible environmental corrections
BS EN ISO 11202:2010 Acoustic.	Noise emitted by machinery and equipment. Determination of emission sound pressure levels at a workstation and at other specified positions applying approximate environmental corrections
BS EN ISO 11203:2009 Acoustics.	Noise emitted by machinery and equipment. Determination of emission sound pressure levels at a workstation and at other specified positions from the sound power level
BS EN ISO 11204:2010 Acoustic.	Noise emitted by machinery and equipment. Determination of emission sound pressure levels at a workstation and at other specified positions applying accurate environmental corrections
BS EN ISO 11205:2009 Acoustics.	Noise emitted by machinery and equipment. Engineering method for the determination of emission sound pressure levels in situ at the workstation and at other specified positions using sound intensity
BS EN ISO 11688-1:2009 Acoustic.	Recommended practice for the design of low-noise machinery and equipment. Planning
BS EN 12198-1:2000 +A1:2008 Safety of machinery.	Assessment and reduction of risks arising from radiation emitted by machinery. General principles
BS EN 12198-2:2002 +A1:2008 Safety of machinery.	Assessment and reduction of risks arising from radiation emitted by machinery. Radiation emission measurement procedure
BS EN 12198-3:2002 +A1:2008 Safety of machinery.	Assessment and reduction of risks arising from radiation emitted by machinery. Reduction of radiation by attenuation or screening
BS EN ISO 13732-1:2008 Ergonomics of the thermal environment.	Methods for the assessment of human responses to contact with surfaces. Hot surfaces
EN ISO 13732-3:2008 Ergonomics of the thermal environment.	Methods for the assessment of human responses to contact with surfaces. Cold surfaces
BS EN ISO 13850:20015 Safety of machinery.	Emergency stop. Principles for design

Safety Standard	Description
BS EN ISO 13855:2010 Safety of machinery.	Positioning of safeguards with respect to the approach speeds of parts of the human body
BS EN ISO 13856-1:2013 Safety of machinery.	Pressure-sensitive protective devices. General principles for design and testing of pressure-sensitive mats and pressure-sensitive floors
BS EN ISO 13856-2:2013 Safety of machinery.	Pressure-sensitive protective devices. General principles for design and testing of pressure-sensitive edges and pressure-sensitive bars
BS EN ISO 13856-3:2013 Safety of machinery.	Pressure-sensitive protective devices. General principles for design and testing of pressure-sensitive bumpers, plates, wires and similar devices
BS EN ISO 13857:2008 Safety of machinery.	Safety distances to prevent hazard zones being reached by upper and lower limbs
BS EN ISO 14118:2018 Safety of machinery	Prevention of unexpected start-up
BS EN ISO 14119:2013 Safety of machinery.	Interlocking devices associated with guards. Principles for design and selection
BS EN ISO 14123-1:2015 Safety of machinery.	Reduction of risks to health from hazardous substances emitted by machinery. Principles and specifications for machinery manufacturers
BS EN ISO 14123-2:2015 Safety of machinery.	Reduction of risks to health from hazardous substances emitted by machinery. Methodology leading to verification procedures
BS EN ISO 14122-1:2016 Safety of machinery.	Permanent means of access to machinery. Choice of fixed means and general requirements of access
BS EN ISO 14159:2008 Safety of machinery.	Hygiene requirements for the design of machinery
BS EN ISO 14738:2008 Safety of machinery.	Anthropometric requirements for the design of workstations at machinery. Anthropometric requirements for the design of workstations at machinery
BS EN 60204-1:2018 Safety of machinery.	Electrical equipment of machines. General requirements
BS EN 61310-1:2008 Safety of machinery.	Indication, marking and actuation. Requirements for visual, auditory and tactile signals
BS EN 61310-2:2008 Safety of machinery.	Indication, marking and actuation. Requirements for marking

Safety Standard	Description
BS EN 61310-3:2008 Safety of machinery.	Indication, marking and actuation. Requirements for the location and operation of actuators
BS EN 61496-1:2013 Safety of machinery.	Electro-sensitive protective equipment. General requirements and tests
BS EN 62061:2005 +A2:2015 Safety of machinery.	Functional safety of safety-related electrical, electronic and programmable electronic control systems

C-type standards

These deal with safety requirements for particular types of machine or groups of machine. When a C-type standard deviates from an A-type or B-type standard, the C-type standard takes precedence. NB the following list is not exhaustive.

Safety Standard	Description
BS EN 415-1:2014 Safety of packaging machines.	Terminology and classification of packaging machines and associated equipment
BS EN 415-3:1999 +A1:2009 Safety of packaging machines.	Form, fill and seal machines
BS EN 415-5:2006 +A1:2009 Safety of packaging machines.	Wrapping machines
BS EN 415-6:2013 Safety of packaging machines.	Pallet wrapping machines
BS EN 415-7:2006 +A1:2008 Safety of packaging machines Group and secondary packaging machines	Safety-related parts of control systems. Validation
BS EN 415-8:2008 Safety of packaging machines.	Strapping machines
BS EN 415-10:2014 Safety of packaging machines.	General Requirements
BS EN 618:2002 +A1:2010 Continuous handling equipment and systems.	Safety and EMC requirements for equipment for mechanical handling of bulk materials except fixed belt conveyors.
BS EN 619:2002+A1:2010 Continuous handling equipment and systems.	Safety and EMC requirements for equipment for mechanical handling of unit loads.

Safety Standard	Description
BS EN 620:2002 +A1:2010 Continuous handling equipment and systems.	Safety and EMC requirements for fixed belt conveyors for bulk materials
BS EN 1010-1:2004 +A1:2010 Safety of machinery.	Safety requirements for the design and construction of printing and paper converting machines. Common requirements
BS EN 1034-1:2000 +A1:2010 Safety of machinery.	Safety requirements for the design and construction of paper-making and finishing machines. Common requirements
BS EN ISO 10218-1:2011 Robots and robotic devices.	Safety requirements for industrial robots. Robots
BS EN ISO 10218-2:2011 Robots and robotic devices.	Safety requirements for industrial robots. Robots systems and integration
BS EN ISO 11553-1:2008 Safety of machinery.	Laser processing machines. General safety requirements
BS EN 12622:2009 +A1:2013 Safety of machine tools.	Hydraulic press brakes
BS EN 12717:2001 +A1:2009 Safety of machine tools.	Drilling machines
BS EN 13736:2003 +A1:2009 Safety of machine tools	Pneumatic Presses
BS EN ISO 16089:2015 Machine tools. Safety.	Stationary grinding machines
BS EN ISO 16090-1:2018 Machine tools safety.	Machining centres, Milling machines, Transfer machines. Safety requirements
BS EN ISO 16092-1:2018 Machine tools safety.	Presses. General safety requirements
BS EN ISO 16092-3:2018 Machine tools safety.	Presses. Safety requirements for hydraulic presses
BS EN ISO 16093:2017 Machine tools. Safety.	Sawing machines for cold metal
BS EN ISO 23125:2015 Machine tools. Safety.	Turning machines

Non-harmonised standards and other documents

Safety Standard	Description
BS EN 415-2:2000 Safety of packaging machines.	Pre-formed rigid container packaging machines
BS EN 415-4:1998 Safety of packaging machines.	Palletizers and depalletizers
BS EN 1005-5:2007 Safety of machinery.	Human physical performance. Risk assessment for repetitive handling at high frequency
BS 4163:2014 Health and safety for design and technology in schools and similar establishments.	Code of practice
BS 4531:1986 Specification for portable and mobile troughed belt conveyors	
BS 5667-1:1979 (ISO 1819-1977) Specification for continuous mechanical handling equipmentsafety requirements.	General
BS 6753:1986 Specification for shotbolts (solenoid operated) for guarding machinery	
BS EN ISO 9614-2:1997 Acoustics.	Determination of sound power levels of noise sources using sound intensity. Measurement by scanning
BS EN ISO/TR 11688-2:2001 Acoustics.	Recommended practice for the design of low-noise machinery and equipment. Introduction to the physics of low-noise design
BS EN 13861:2011 Safety of machinery.	Guidance for the application of ergonomics standards in the design of machinery
PD ISO/TR 18569:2004 Safety of machinery.	Guidelines for the understanding and use of safety of machinery standards
PD ISO/TS 19837:2018 Safety of machinery.	Trapped key interlocking devices. Principles for design and selection
PD ISO/TR 23849:2010	
PD IEC/TR 62061-1:2010 Guidance on the application of ISO 13849-1 and IEC 62061 in the design of safety-related control systems for machinery	

Safety Standard	Description
BS EN 61496-2:2013 Safety of machinery.	Electro-sensitive protective equipment. Particular requirements for equipment using active opto-electronic protective devices (AOPDs)
PD IEC/TR 61496-4:2007 Safety of machinery.	Electro-sensitive protective equipment. Particular requirements for equipment using vision-based protective devices (VBPD)
PD IEC/TS 61496-4-2:2014 Safety of machinery.	Electro-sensitive protective equipment. Particular requirements for equipment using vision-based protective devices (VBPD). Additional requirements when using reference pattern techniques (VBPDP)
PD IEC/TS 61496-4-3:2015 Safety of machinery.	Electro-sensitive protective equipment. Particular requirements for equipment using vision-based protective devices (VBPD). Additional requirements when using stereo vision techniques (VBPDPST)
17/30356573 DC (BS IEC 62046, draft for public comment) Safety of machinery.	Application of protective equipment to detect the presence of persons

Other types of machinery, from cranes to sewing machines, also have their own requirements. A full list of standards harmonised to the Machinery Directive is available on the European Commission's website (see 'Useful Resources' in On Your Guard, the Designer's Guide to Machinery Guarding Standards).

Appendix

Useful resources - Further information

Procter Machine Safety

Tel: 02920 855 758

Email: info@machinesafety.co.uk

www.machinesafety.co.uk

SATECH (low-cost modular perimeter guards)

Tel: 02920 855 754

Email: satech@machinesafety.co.uk

www.machinesafety.co.uk/satech

Nelsa (standard machine shop guards from Procter)

Tel: 02920 855 751

Email: nelsa@machinesafety.co.uk

www.machinesafety.co.uk/nelsa

BSI

Tel: 0345 086 9001

Email: cservices@bsigroup.com

www.shop.bsigroup.com

Health and Safety Executive

Tel: 0300 003 1747

www.hse.gov.uk

Please ensure that you report all accidents or incidents.

If you see anything on your sites or customer sites that you think is unsafe, it is okay to Stop and Report it to us as a Near Miss.

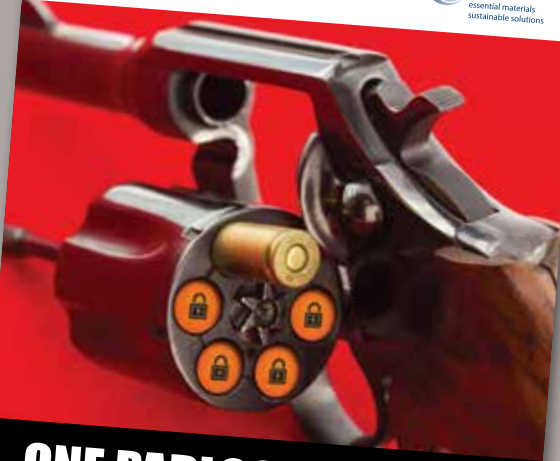

mpa
essential materials
sustainable solutions

**ONE PADLOCK, ONE KEY,
ONE CHANCE**

Every year 800 people are killed or severely injured by moving machinery in the UK workplace.



essential materials
sustainable solutions

Mineral Products Association

38-44 Gillingham Street
London SW1V 1HU

Tel 020 7963 8000
Fax 020 7963 8001
info@mineralproducts.org
www.mineralproducts.org

The Mineral Products Association is the trade association for the aggregates, asphalt, cement, concrete, dimension stone, lime, mortar and silica sand industries.

For further MPA information visit
www.mineralproducts.org
www.safequarry.com

Printed on paper from well-managed forests, controlled sources and recycled wood or fibre.
FSC accredited: TT-COC-002651